



Mineral Products Association

Workplace Transport & Pedestrian Interface Handbook

The narrative and practical examples used in this document have been taken from the significant amount of materials that were received from MPA members after a request for sharing best practice. Thank you to all those that contributed with the singular uncompromising objective to reduce the risk of contact with workplace transport and pedestrians.

Background

In 2017 the Mineral Products industry saw an unprecedented number of incidents that resulted in fatal consequences across the mineral product sector. In response, and at the request of MPA Council and Board, the MPA Health and Safety Committee looked back at the fatal incidents over the last decade, identifying 6 high consequence hazards, 'The Fatal 6', that have been the main cause of fatalities over that period. The identified 'The Fatal 6' high consequence hazards are: **Contact with moving machinery and isolation (including stored energy), Workplace transport and pedestrian interface, Work at height, Workplace respirable crystalline silica, Struck by moving or falling object, Road traffic accidents.** A working group involving MPA members has been established for each topic to develop useful guidance and resources, helping to make a difference by reducing the risk of these high consequence hazards occurring across the industry.

Adopting a systematic and holistic approach to managing risk and inculcating a safety culture will protect employees and all those affected by workplace activities.

The factors that give rise to risk are interdependent and cannot be examined in isolation, it is vital therefore when managing risk to be aware of this interdependency. There are numerous factors that influence good risk management, the most successful capture the requirements of both legal compliance and influencing safe behaviors, but never considered as one being more important than the other.

The simple risk management diagram gives a holistic overview of what you might consider and how they interact.



Introduction

Every year, there are over 5,000 accidents involving transport in the workplace. About 50 of these result in people being killed (www.hse.gov.uk/statistics). The main causes of injury are people falling off vehicles or being struck or crushed by them. These statistics are indicative of what we see within our own sector and have been identified as one of our 'The Fatal 6' High Consequence Hazards.

This handbook has been jointly developed by the members of the Mineral Products Association (MPA) Vehicles and Pedestrians Health and Safety Working Group, as a tool for sites to help them understand and control the typical risks that they manage in environments where vehicles and pedestrians interact.

This is a best practice document, but using the information given should help you to comply with your statutory duties in respect of safe site practices. The document's contents are not exhaustive and it provides information, in no particular order, on the main risks that both vehicle and plant drivers and operators face, as well as pedestrians, as part of their everyday working lives in our industry.

All information contained in this document is accurate at the time of publication (Feb 2020). It is the responsibility of the reader to ensure they update themselves regularly on any changes to legislation relevant to their duties.

More detailed information on general road and workplace health and safety can be found in the appendices at the rear of this document.

Contents

- 3 Acknowledgement
- 6 The PDCA Cycle
- 12 Best Practice Action Plan
- 14 H & S Pedestrian & Vehicle Segregation Action Plan 2019
- 17 People Safer by Competence**
- 18 The Theory of Risk Management
- 20 Risk Management Matrix
- 22 Roles Leadership Play
- 24 Sustainable H & S Performance
- 30 Good Safety Conversation
- 34 Example of Good Safety Conversation
- 36 PPE
- 38 Best Practice PPE – Operatives
- 40 Best Practice PPE – Ex Works / Collect Customers
- 42 Drugs & Alcohol at Work
- 44 Eligibility to Drive
- 45 Fitness & Health
- 46 Understanding Competence
- 47 Training
- 48 Best Practice Training
- 52 Safe Behaviours & Expectations
- 54 Case Study – Safe Behaviours & Expectations
- 57 Plant Safer by Design**
- 58 Safer by Design
- 60 Plant Covered by Safer by Design
- 61 “The Fatal 6” & Key Issues Covered by Safer by Design
- 62 Assessing Safer by Design
- 63 Safer by Design and International Standards
- 64 Vehicles
- 66 Vehicle Standards
- 72 Road Vehicles

Contents

- 72 Common Standards for Aggregates & Asphalt Tipper Vehicles – LGVs
- 74 Visibility Zones
- 76 Site Vehicles
- 78 Common Standards for Site Vehicles
- 80 Ancillary Vehicles
- 82 Vehicle Equipment
- 83 Best Practice Vehicle Equipment
- 92 Best Practice Changing Weather
- 97 Process Safer by Sharing**
- 98 Inductions
- 104 Example of Induction Best Practice
- 108 Collect Customer Rule When Visiting Site
- 110 Vehicle Management
- 111 Best Practice Vehicle Management
- 112 Best Practice Entrance Signage
- 113 Best Practice Signage
- 114 Best Practice Vehicle Exclusion Zones
- 116 Best Practice Pedestrian Routes
- 118 Best Practice Traffic Direction
- 119 Best Practice Speed Limit
- 120 Best Practice Parking
- 121 Best Practice Reverse Parking Policy
- 122 Best Practice Edge protection
- 123 Best Practice Slopes & Gradients
- 124 Best Practice Loading & Discharge
- 126 Example of Best Practice Site Plan
- 133 Example of Best Practice Managing Special Hazards
- 133 Performance safer by Association**
- 136 Auditing
- 142 Incident/ Near Miss Investigation
- 144 Leading / Lagging Indicators
- 146 Reference/Weblinks**





The PDCA cycle

This guide follows the Plan, Do, Check, Act (PDCA) approach to explore a variety of factors aimed at reducing incidents involving vehicles and pedestrians. The PDCA framework is a practical way for businesses to make positive changes above the minimum standards

The PDCA approach achieves a balance between the systems and behavioural aspects of management. It also treats health and safety management as an integral part of good management generally, rather than as a stand-alone system.

PDCA can be applied to vehicle and pedestrian management in exactly the same way as it can in other parts of the health and safety (H&S) Strategy for a company.

Firstly, using risk assessment principles we need to establish where these risks are apparent using data and incident analysis tools, and ensure that we have the required knowledge on how these risks are controlled, benchmark against industry best practice and evaluate our existing procedures to see if they are fit for purpose.

We need to look for easy, simple and effective traffic management plans and procedures to give our managers the tools to “self assess” their operations and understand how each one of those risks can be controlled and mitigated, with clear guidance on where to find the equipment and signage required.

However, it is not just physical equipment and walkways we need to control; we have to understand the implications of employee and contractor behaviour as we look to enhance either the control measures in place or the ones we intend to add.

Why and how these control measures work, why they are required, and appropriate checks of applicability and feedback mechanisms need to be communicated effectively to everyone.

Only then can we ensure that the interfaces between our people, contractors, plant and visitors can be effectively controlled in line with good practice.





The PLAN stage establishes where a business is starting from and where it intends to get to:

- Say what a business wants to achieve, who will be responsible for what, how these aims will be achieved and how success will be measured. It is recommended to write down this policy in order to effectively deliver it
- Decide how the business will measure performance. Think about ways to do this that go beyond looking at accident figures; look for leading as well as lagging indicators
- Remember to plan for changes and identify any specific legal requirements that apply to the business.



Do – Identify the business risk profile

- Assess the risks, identify what could cause harm in the workplace, who it could harm and how, and what can be done to manage the risk
- Decide what the priorities are and identify the significant risks.

Do – Organise any activities to deliver the PLAN with the aim to:

- Involve workers and communicate, so that everyone is clear on what is needed and can discuss issues
- Develop positive attitudes and behaviours
- Provide adequate resources, including competent advice where needed.

Do - Implement the PLAN

- Decide on the preventive and protective measures needed, and put them in place
- Provide the right tools and equipment to do the job, and keep them maintained
- Train and instruct, to ensure everyone is competent to carry out their work
- Supervise to make sure that arrangements are followed.





Measure the performance

- Make sure that the PLANs have been implemented; ‘paperwork’ on its own is not a good performance measure
- Assess how well the risks are being controlled and if the business is achieving its aims. In some circumstances, formal audits may be useful
- Investigate the root causes of accidents, incidents or near misses/hits

PDCA cycle - understanding your risk profile

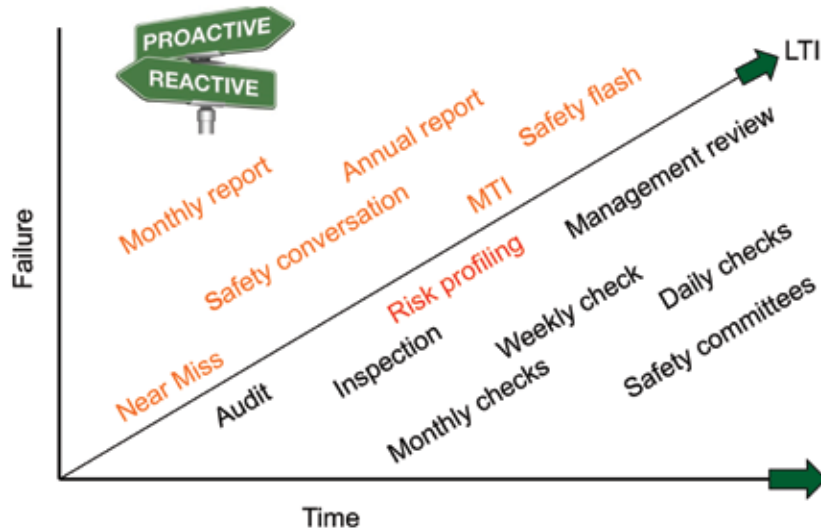

Review the performance

- Learn from accidents and incidents, ill-health data, errors and relevant experience, including from other organisations
- Revisit plans, policy documents and risk assessments to see if they need updating, review any site inductions and review close and effective supervision if required.
- Take action on lessons learned, including from audit, inspection reports, reviews, safety conversations, misses/hits, etc.

PDCA cycle - preventing recurrence

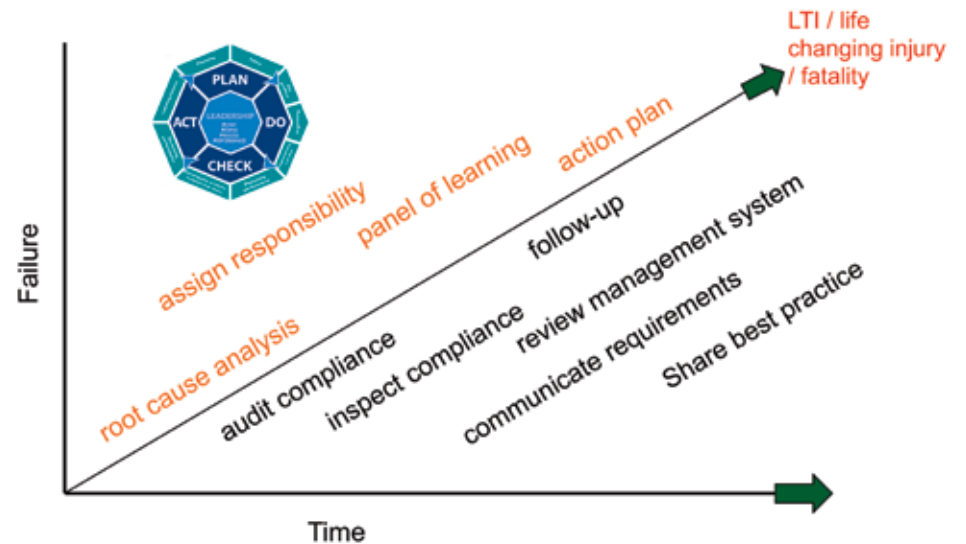

Best Practice Action Plan

A critical part of the PDCA cycle discussed in the earlier pages is to formalise the whole process into an action plan. This plan should be the coordinating document pulling together all the initiatives that emerge from the detailed risk profiling of the business and should include the actions identified as part of the analysis of both “reactive” and “proactive” information being recorded in the business.

An example of a document is shown overleaf. All businesses with good H&S performance ensure effective management of all processes in the business. It is not about procedures, though they are part of the processes; it is about managing risk, demonstrating leadership and engaging staff.

A strategy-focused PDCA plan should therefore contain items from the company vision and new procedures coming through, as well as links to other functions such as communications, HR and finance.

There are several inputs, some of which are listed below:

1. Company Vision & Policy
2. H&S Plan
3. Management Review
4. Targets & Goals for the Business
5. Management H&S Objectives
6. Employee Engagement & Incentives Processes
7. Risk Profiling Process & Actions
8. Safety Committee Feedback
9. Budget & Resource Requirements
10. Gap Analysis against Legal & Recognised Good Practice
11. Reporting & Sharing Good Practice Processes
12. H&S Procedural Processes
13. Health, Sickness & Wellbeing Processes
14. Auditing & Monitoring Processes
15. Communications
16. Training & Competence

Health & Safety Pedestrian & Vehicle Segregation Action Plan - 2019

							Document Detail																	
It is essential for the company to have an effective procedure and management plan to control the risks created when people, plant and vehicles interact with each other. This plan is designed to pick up the major points to create an effective plan in order to control these risks on a strategic level within our business. The action plan coordinates the various required details in order to deliver a noticeable reduction in site incidents and near hits/misses.							Plan Created by:						H&S Manager											
							Date Created:						01.01.2019											
							Approved by _____:						Board											
							Authorised By:						MD											
							Review Timescales:						Six Monthly											
Date for Review:						01.07.2019																		
							Targets and milestones																	
Action							Target Date	Responsible	Name	Consult	Inform	Planned		In Progress			Complete							
Action							Target Date	Responsible	Name	Consult	Inform	Jan	Feb	Mar	Apr	May	Jun	Jul	Aug	Sep	Oct	Nov	Dec	2020
A. Strategic Actions																								
1		Formulate a traffic management plan master sheet to assist sites in highlighting the risk factors (to include traffic flows, pedestrian routes, existing control measures and include a risk assessment matrix to highlight priority).	01/04/2019	H&S manager	TBC	Board	All Managers																	
2		Establish and identify all potential risk factors to include (types of pedestrians, vehicle types, specific site hazards, traffic areas affected).	01/02/2019	H&S Manager	TBC	Site Managers	Board																	
3		Create a guidance document to advise managers on pedestrian and vehicle segregation risks and how to control them.	01/02/2019	H&S Manager	TBC	HSE Guidance	Board																	
4		Formulate a strategic plan for the business on each element of the master sheet in order for priorities on a company wide basis to be achieved and any CAPEX confirmed.	01/11/2019	H&S Manager	TBC	Site Managers	Board																	
B. Procedural Actions																								
1		Create a Pedestrian & Vehicle Segregation procedure together with associated tool box talk, guidance and plans for the business.	01/04/2019	H&S Manager	TBC	Site Managers	Board																	
2		Research and create a guidance document showing what is currently available to control risks (vision aids mobile plant, traffic lights, barriers, signage, walkways etc). Document finalised COMPLETE.	01/04/2019	H&S Manager	TBC	Site Managers	Board																	
3		Ensure a training programme is put together ensuring H&S Managers are fully up-to-date with current best guidance and benchmark competitors and other industries where this is a larger risk.	01.03.2019	H&S manager	TBC	External	Board																	
C. Site Related Actions (e.g. Leicester plant)																								
1		Create a traffic management plan for the site on company proforma.	01/09/2019	Site Manager	TBC	Area Manager	H&S Team																	
2		Train all existing staff on new procedures and ensure employee involvement.	01/09/2019	Site Manager	TBC	Area Manager	H&S Team																	
3		Fit reversing cameras to yellow machines and new doors needed for pedestrian entry into packing shed where FLT's operate	01/09/2019	Site Manager	TBC	Area Manager	H&S Team																	
4		New pedestrian walkways required for car parks to offices and from office to control room.	01/09/2019	Site Manager	TBC	Area Manager	H&S Team																	



People Safer by Competence

The Theory of Risk Management



Once the PLAN of the PDCA approach is in place, the measures of success will be clearly established. It is at this point a business must identify where it is starting from by compiling a risk profile.

Identifying a risk profile after you have settled on a PLAN doesn't change the PLAN; it identifies how much work a business needs to do to achieve success.

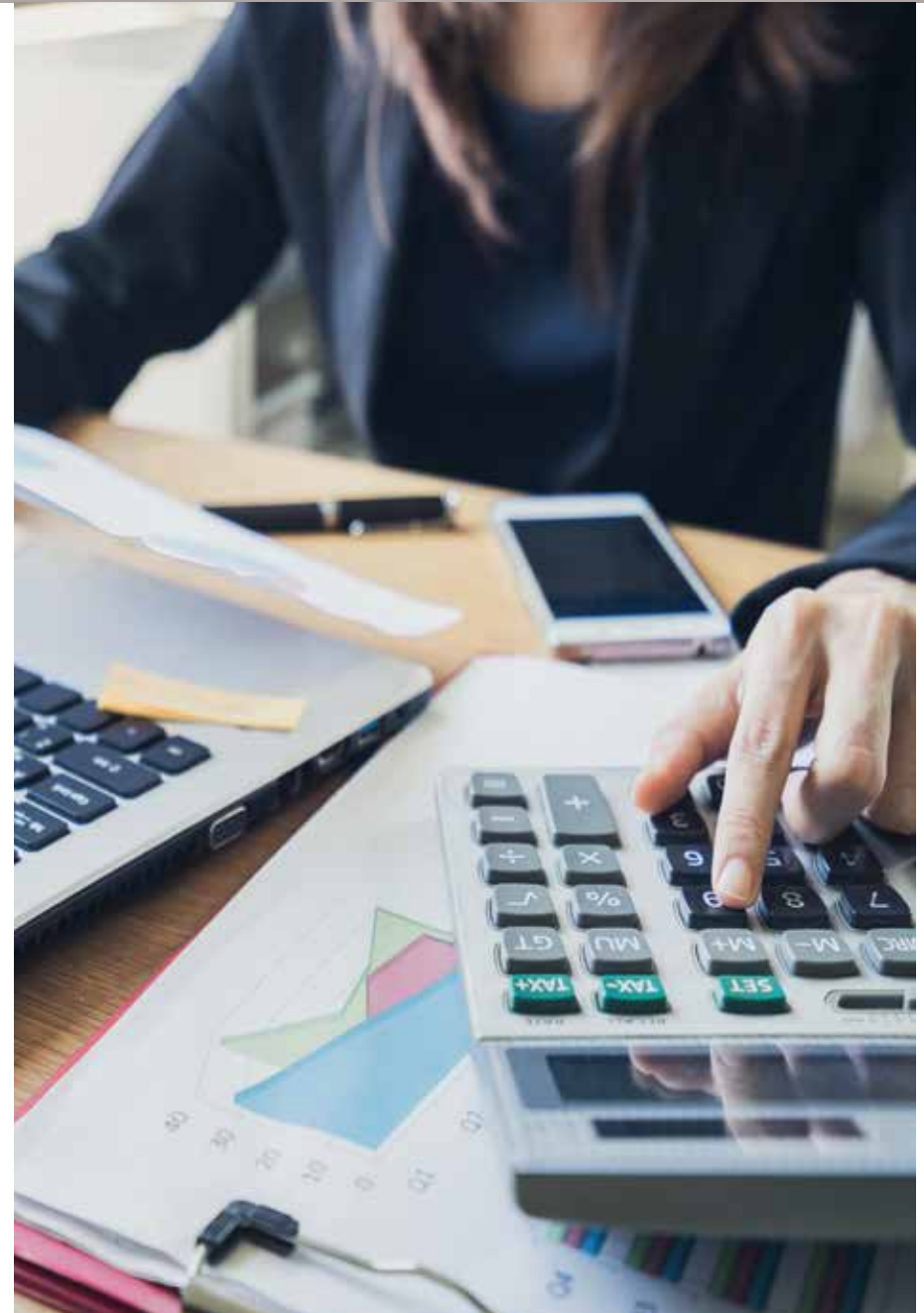
These Risk Management tools are provided for the most common environments within the mineral industry; however, they don't take into account company nuances or change processes. They are part of a wide range of tools a business can utilise to facilitate the DO stage of the PDCA approach.

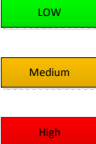

Risk Management Matrix

Title		PLAN	Do	
Plan, Do, Check, Act		Develop Policy; Identify Objectives; Identify Responsibilities; Identify Roles; Develop Traffic Management Plan; Develop Audit Strategy.		Conduct Risk Assessment; Identify Low, Medium and High-Risk Areas; Distribute Responsibilities; Implement Traffic Management Plan; Complete Near Misses; Complete Safety Forums.
				
General	Management /Working Group to Review/Develop Policies and Strategy and Identify Roles and Responsibilities.	A detailed Risk Assessment to be developed to Identify Low, Medium and High-Risk Areas with the development of a Traffic/Pedestrian Management Plan to include Roles and Responsibilities, Site Rules and a Layout Plan Drawing of the developed Safe System of Work. Near Misses to be raised where risks and hazards have been identified. Employee Forums to openly discuss issues identified within the facility with regards to Traffic/Pedestrian Management.		
Offices	To Be Represented in Working Group By a Minimum of One Attendee; Champion/Responsible Person to be Identified.	Pedestrian Crossings, Delineation; Reverse Parking Only; Relevant Signage.	As Low Risk Plus Pedestrian Guard Rail. As Medium Risk Plus Pedestrian Safety Barriers (High Impact).	
Yard/Depots	To Be Represented in Working Group By a Minimum of Two Attendees; Champion/Responsible Person to be Identified.	As All Control Measures Above Plus Consider Potential For One Way Systems.	As Low Plus Consider Gated Entrances to Crossings. As Medium Plus Consider Traffic Light Controlled Pedestrian Crossings and Assisted Parking.	
Plants	To Be Represented in Working Group By a Minimum of Two Attendees; Champion/Responsible Person to be Identified.	As All Control Measures Above.	As Low Plus Consider Strategically Placed Refuge Areas and Forward Parking Only (Drive In/Drive Out) and Suspension of All Pedestrian Manoeuvres During Vehicle Movements and Vice Versa.	
Quarries	To Be Represented in Working Group By a Minimum of Two Attendees; Champion/Responsible Person to be Identified.	As All Control Measures Above.	Prohibition of Pedestrians in Heavy Vehicle/ Heavy Plant Occupied Areas.	
KEY Guidance		When Assessing whether Offices, Yards/Depots, Plants or Quarries are deemed Low, Medium or High Risk, please consider the following: - <ul style="list-style-type: none"> • Pedestrian Count also taking into consideration peak time requirements; • Vehicle Count also taking into consideration peak time requirements and correlation with pedestrian movements; • Current Accident Statistics and Near Misses being raised on Traffic Management issues; • Current evaluation on advised Control Measures. 		

Check		Act	
	Conduct Audits; Conduct Safety Inspections/Tours; Review Near Misses; Review Accidents/Incidents; Review Safety Forums.		Review Audit and Inspection Results; Identify Corrective, Preventive Actions and Trends; Identify Improvements; Implement Improvements; Communicate.
			
Site-specific Audits on Traffic and Pedestrian Flows to confirm assessments; Management, Supervisors and Safety Department to conduct regular inspections; frequency dependent on Risk Assessment; Review all Near Misses and Identify Remedial Action and Implement; Investigate all Accidents and Identify Corrective/Preventive Actions and Manage via a Improvement Plan; Review Raised Safety Concerns and Potential Improvements and Implement.		Identify Trend Analysis from Audit and Inspection Results and devise and Implement Improvement Plans; Communicate Findings and Results to Workforce; Confirm Effectiveness of Improvement Plans; Included As an Agenda Item at Relevant Meetings.	
Monthly Checks on condition of Safety Equipment; Periodic Maintenance as defined by Monthly Inspections; Management of Near Misses Reported.		Quarterly Management Meetings to Discuss Findings; Publish Dashboards or Reports; Review Effectiveness of Relevant Management System.	
Monthly Checks on condition of Safety Equipment; Periodic Maintenance as defined by Monthly Inspections; Management of Near Misses Reported.	Weekly Checks on condition of Safety Equipment; Periodic Maintenance as defined by Weekly Inspections;	Quarterly Management Meetings to Discuss Findings; Publish Dashboards or Reports; Review Effectiveness of Relevant Management System.	
Weekly Checks on condition of Safety Equipment; Periodic Maintenance as defined by Weekly Inspections; Management of Near Misses Reported.		Monthly Management Meetings to Discuss Findings; Publish Dashboards or Reports; Review Effectiveness of Relevant Management System	
Weekly Checks on condition of Safety Equipment; Periodic Maintenance as defined by Weekly Inspections; Management of Near Misses Reported.		Monthly Management Meetings to Discuss Findings; Publish Dashboards or Reports; Review Effectiveness of Relevant Management System.	
On determining whether the Offices, Yards/Depots, Plants or Quarries are deemed Low, Medium or High, please conduct the following: <ul style="list-style-type: none"> • Develop an Improvement Plan where the current Control Measures do not meet the advised level of control; • Use (SMART) Specific, Measureable, Achievable, Relevant and Time-Based objectives; • Monitor the Improvement Plan on the basis of Plan, Do, Check and Act. 		Periodically and on Completion of the Improvement Plan, please conduct the following: <ul style="list-style-type: none"> • Conduct Inspections and Audits to evaluate progress; • Close Out the Actions when completed and provide updates at Quarterly/Monthly Meetings; • Update the Risk Assessment with the improved Control Measures which should identify a decrease in risk. 	

What role does leadership play when considering Vehicle and Pedestrian Safety?

Organisations, and the directors and managers that run them, have to understand firstly what health and safety leadership is and why it is so important. While they need to understand their legal responsibilities for the positions they hold, it is the H&S Leadership in their organisation that will be the determining factor in making progress to create a strong H&S culture and developing a safer and healthier workforce.

Managers have to understand that H&S is a business process in the same way that finance, HR, purchasing, sales etc. are. While warm words such as “H&S is our number one priority” are important, it is the understanding that H&S process requires dedicated management time and resources that makes the biggest impact. This is not found to be the case in practice when examined in detail.

So all this requires planning and resources, but the senior leadership has to take full responsibility for H&S culture and processes in the business. It is the leadership’s visible commitment to H&S that is the key to holding the segments of the H&S system together and creating a sustainable, long term safety culture improvement. Safety is a “line management” responsibility, which is why so many H&S professionals prefer to be referred to as advisors or business partners as opposed to H&S managers or directors.

Senior leaders also have to understand that it’s not just about incidents, it’s about ZERO HARM as a strategic vision, so we have to look at incidents, health and sickness in the workplace as a whole. They also have to believe it is possible; and it is!



H&S being led from the top is the most effective approach any organisation can adopt. Not only does a business face legal responsibility, it also has moral responsibilities to achieve a safer and healthier workforce.

When managers understand that H&S is a business process in the same way that other business functions like sales or IT are, the values associated with it become truly felt, believed and embraced by the wider workforce. This is the core to Visible Felt Leadership (VFL).

Many companies will endorse a H&S mantra such as “Safety as a number 1 priority” or “Zero Harm”, however the time and resources put behind these mantras is often lacking. VFL requires planning and resources to conduct, but once committed-to has been proven to creating a sustainable, long-term culture improvement.

When considering Vehicles and Pedestrians, VFL would facilitate:

- Everyone on site to look out for one another rather than an ‘us vs them’ mentality or ‘blame culture’
- Site Manager and Supervisors to take proactive measures to improving vehicles and equipment, sites and processes.
- Drivers and Pedestrians to speak up or suggest changes where improvements could be made
- Safety to become everyone’s responsibility as the business moves towards an interdependent culture.

Sustainable H&S performance

When considering the business approach to vehicles and pedestrians, the strategic approach as outlined in this guide goes above and beyond incidents, instead taking a holistic approach encompassing incidents, health and sickness between vehicle drivers and pedestrians.

A way of introducing senior executives to the concepts of Safety Leadership is through engaging with course materials such as Institution of Occupational Safety and Health (IOSH) Leading Safety in conjunction with the MPA or H&S for Directors courses. The training of all senior leaders on VFL is critical.

The first challenge for leaders is to understand ALL incidents are avoidable. Vehicle blind spots can be overcome, and pedestrians can always be segregated. This first step is difficult for some business leaders to accept. Commonly the reaction of leaders to an incident - for instance, a worker being struck by a fork lift truck - is to put in place better procedures and physical guarding. However commonly the behaviour aspect of "why were they walking there?" is not fully appreciated. It is this aspect that managers sometimes miss.

Investigations in large organisations indicate the root cause of up to 96% of all incidents can be linked back to human behaviour (the remaining being "acts of god" or equipment failure).

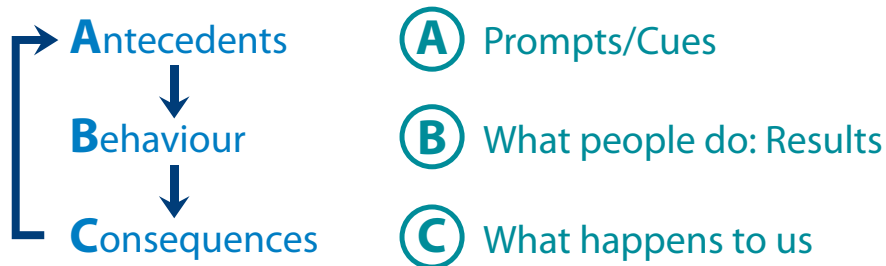

To understand this fully, managers must recognise that, for instance, if the brakes fail on a loading shovel it is not necessarily equipment failure. It could be either the designer made a mistake, the manufacturer put it together wrong, the driver noticed a problem and didn't report it, or a manager got a defect sheet and didn't act. It is not necessarily a "violation", but it could be mistake, error, misjudgement or lapse of concentration. Either way, it all relates to people working in cultures that excuse their behaviour.

VFL training includes the theory around why people do things, as human behaviour is generally predictable. Furthermore, people respond to leadership messages. If the leadership culture pushes for production, this will always be prioritised over safety, whereas when health and safety is the focus, the workforce will follow suit. One useful view of assessing the business H&S maturity is analysing the business' current culture against the Bradley Curve. The DuPont Bradley Curve identifies four stages of safety culture maturity: Reactive, Dependent, Independent and Interdependent.

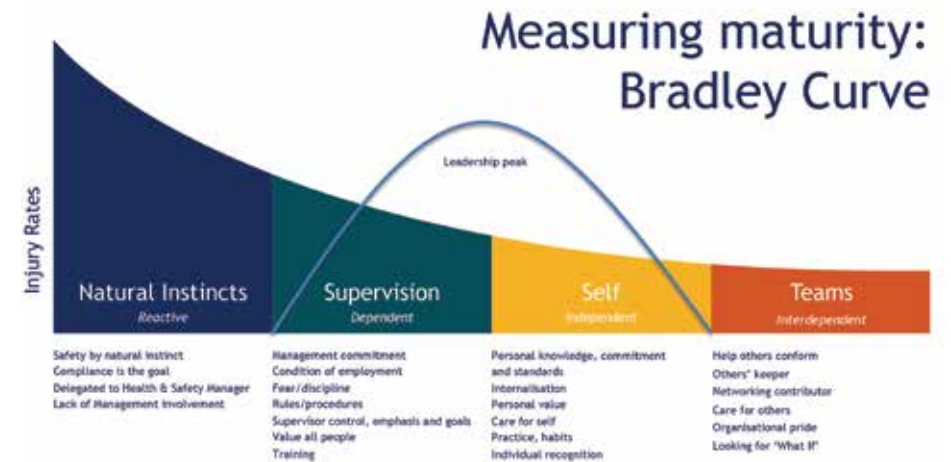

Reactive Stage - People don't take responsibility and believe accidents will happen.

E.g. on a site with no traffic plan in place, following an incident in which an individual is hit by a forklift truck, the business responds by disciplining the injured person.

Dependent Stage - People view safety as following rules. Accident rates decrease.

E.g. on a site with no traffic plan, following an incident in which an individual is hit by a forklift truck, the business responds by issuing a new rule that everyone must cross at designated areas only, and reprimands are distributed when these rules are broken.

Independent Stage - People take responsibility and believe they can make a difference with actions. Accidents reduce further.

E.g. following an incident in which an individual is hit by a forklift truck, the business responds by issuing a safety alert including details of the injuries incurred, reminding everyone to follow the traffic plan so they can go home safely. Supervisors are asked to run a Toolbox Talk on Vehicle and Pedestrian safety asking the question: "How would your life be affected if you were hit by a vehicle?"

Interdependent Stage - Teams feel ownership and responsibility for safety culture. They believe zero injuries is an attainable goal.

E.g. following a near miss in which an individual was almost hit by a forklift truck, the workforce came together in a working group to develop technological solutions in the form of an intelligent traffic system to prevent a future incident. These were budgeted, trialled and rolled out across the wider business.

VFL must be VISIBLE in the workplace. When applied to Vehicles and Pedestrians this means managers need to be on-site, speaking with everyone who comes into contact or is in control of a vehicle. By doing this, the workforce will FEEL the importance of safety coming directly from the LEADERS of the business.

MPA Member - Their Journey

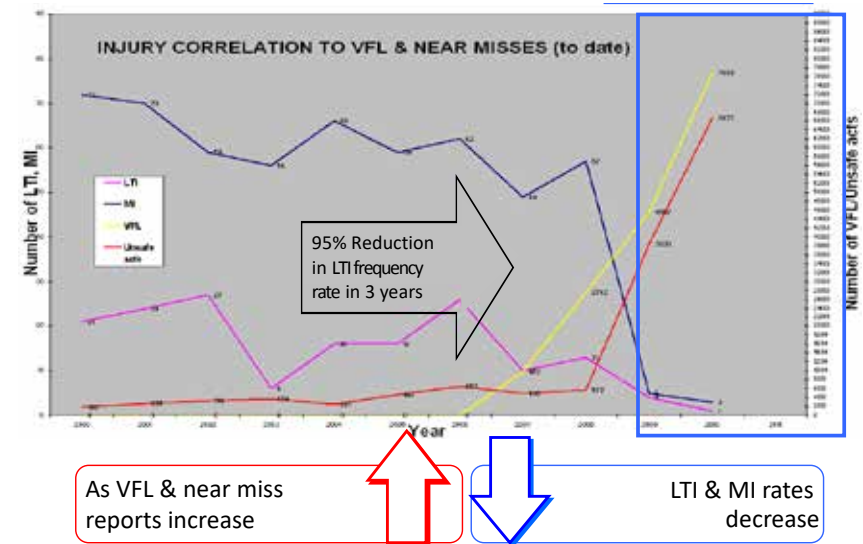

Once in place it must be in management's annual appraisals and bonus schemes to operate effectively and be actively managed. An effective VFL approach will see:

- Incident numbers fall
- Near Miss/Hit numbers rise

The outcome of a successfully engaged management team relies on an understanding that everyone has responsibility for health and safety and that includes other board members of other functions. These roles do not always see safety as part of their responsibilities. Wise organisations ensure that each board member is allocated some part of the H&S system to manage with safety support.



HR should be involved in drugs & alcohol and sickness monitoring as standard so why wouldn't they be involved in the safety processes that support those items? Likewise, would a purchasing director not be involved in contractor databases, contractor control procedures and standardisation of personal protective equipment (PPE) together with group contracts for supply of noise and dust testing, for instance? Therefore, organisations would commonly allocate these directors to work in these groups.

“Operational excellence goes hand in hand with safety excellence”

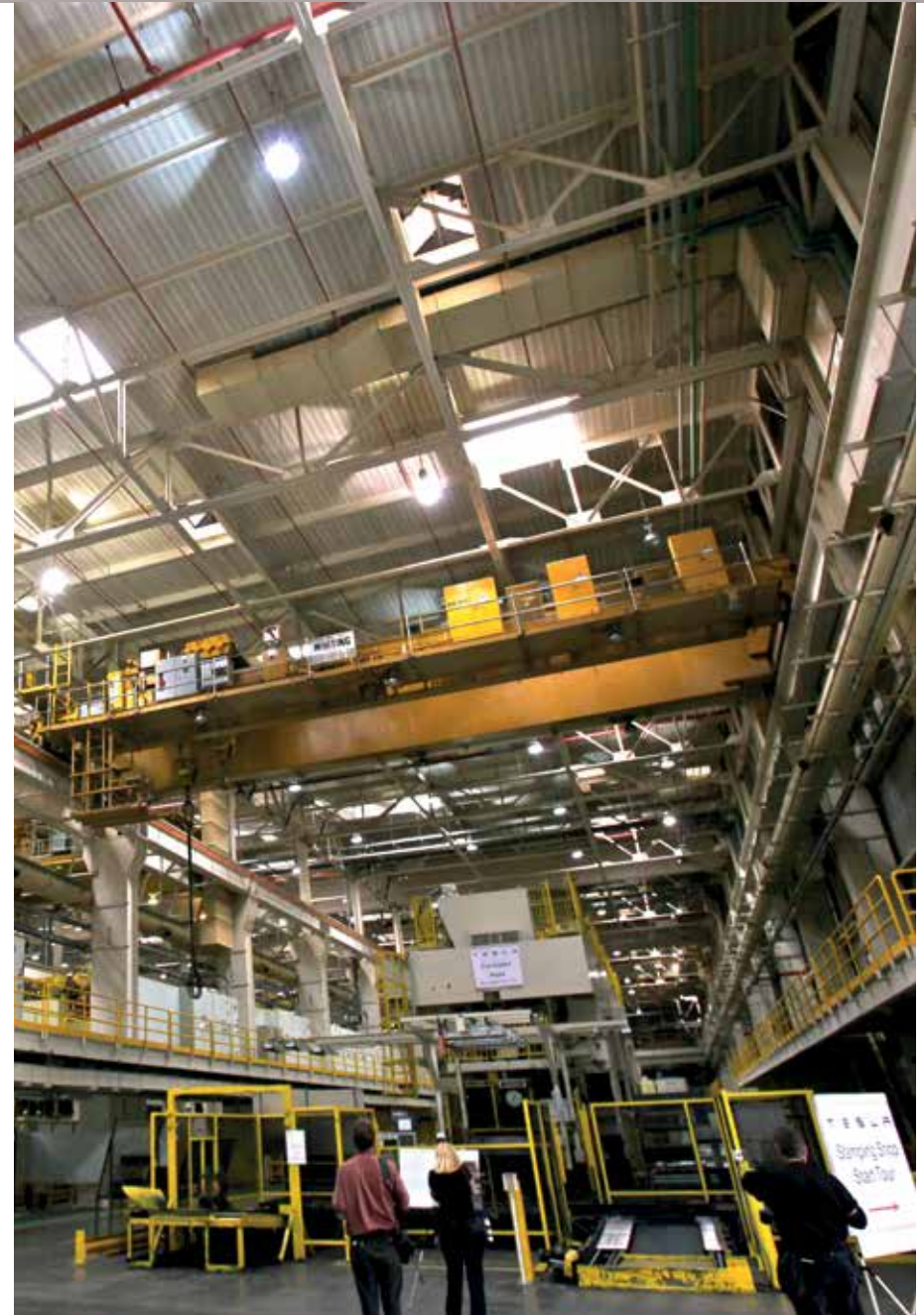

Good Safety Conversation

The Safety Conversation is a practical tool utilised by management, regardless of their function, to practise VFL, in order to promote wider change within a business' organisational culture.

Questions every site should ask:

- Where is the business currently placed on the Bradley Curve?
- What areas should be targeted initially to have the greatest impact on improving safety culture?
- What training do managers need in order to hold an effective Safety Conversation?
- Do managers need any additional resources in order to facilitate a Health and Safety Conversation approach?
- What needs to be communicated to the wider workforce in order to prepare them for what to expect?
- What other tools can be used in combination with Health and Safety Conversations in order to empower the wider workforce to act upon their commitments during these conversations, such as near miss/hit reporting tools?
- How will Safety Conversations be recorded?
- Who will review Safety Conversations and identify trends to send out to those trained?
- How will the results be communicated back to the management team as well as the wider workforce?

How to Conduct a Quality Safety Conversation

Step 1: Stop and observe

Observations give a manager an opportunity to understand the environment that people are working in, as well as the attitude of those people working. Observations should not only include areas for improvement, but opportunities to praise.

Step 2: Introductions (unless a manager is already known by the person)

A safety conversation should begin with the manager offering their name and perhaps some background as to where they are from and what they do. The manager should then always invite the same in return.

Step 3: Tell them what you're doing

For some people, a manager discussing health and safety can be nerve racking (particularly in reactive or dependent cultures), so an introduction of safety conversations can be reassuring. This should be short and to the point e.g. "I'm out on site talking with people about their jobs, to discuss any risks and what we can do to overcome them. Do you have a few minutes to talk?"

Step 4: The task and its stages

Discuss the task being carried out by asking open questions. A manager should never make assumptions about the task, but should work towards having a full understanding of all the stages the task entails. This stage is important: it gives the person the opportunity to get involved in the discussion, and the more they do, the more buy-in they will have for changing their own behaviour.

Step 5: Give praise for safe behaviour, reinforcing good habits.

Step 6: Ask about the worst thing that could happen

A good approach at this stage would be to ask these 3 questions in quick succession:

- “What’s the worst incident that could happen doing this job?”
- “What could be the consequences of that happening?”
- “How could that happen?”

Some tasks or environments may not have obvious hazards, so a manager should learn to probe to ensure that an individual is really doing everything necessary to prevent an accident; not only to themselves, but to others around them. If during the observation stage, a manager sees something that gives them cause for concern, this is a good point at which to ask about it.

Listening skills are key and should be practised by managers before engaging in safety conversations if possible.

VFL is all about listening, so how do we show it?

- Non-verbal response (e.g. nodding)
- Verbal response
- Not showing impatience to speak
- Playback - summarising what the person has said as you go along
- Finally, summarise

Step 7: Find the root cause of any unsafe behaviour or condition

If unsafe behaviour had been identified in step 6, consider the question “why do you take the risk?” in order to establish root cause.

Step 8: Get solutions to the unsafe behaviour or condition.

The aim of any safety conversation is to encourage the workforce to act safely without management supervision. Open questions such as “what can you do?” and “how could you do that?” encourage an individual to generate their own solutions.

Step 9: Get commitment to act.

The key question here is: “When can you do that?” Every accident investigation reveals a plethora of simple solutions AFTER the event, so management should be aiming to use safety conversations to fish out those solutions before the accident even occurs. If several solutions drop out of the discussion, it’s useful to summarise them. Managers should always remember to give praise for the solutions and commitment.



PLAN

Establish where on the Bradley Curve the business currently sits and commit to change starting from the top of the hierarchy and working down.

DO

Train management across all functions on how to conduct a quality safety conversation. Put in place recording databases and analysis tools in order to evaluate high risk areas.

CHECK

In a simple manner, record safety conversations that have been conducted in a central location and consider time frames to review.

ACT

A Safety Conversation approach can take up to three years to become embedded within a culture, so the next PLAN needs to focus on initial success stories within the business to keep the conversations positive.

Example of Good Safety Conversation

MANAGER: Good Morning, my name is Jo and I'm looking to conduct a quick safety conversation, can I ask what your name is?

DRIVER: Usamah

Jo: Usamah? Hi, do you have a quick ten minutes to discuss any safety concerns you might have?

Usamah: Yeah, sure, is this an audit then?

Jo: No, just a safety conversation, a quick chat to discuss safety from your point of view.

Usamah: Oh, okay then, sure.

Jo: Thank you. I notice that you're wearing the correct PPE for this site. How do you know what the PPE rules are for this site?

Usamah: These were issued to me, but there is always a sign when you first drive up that tells you what to wear so I know if I can get out of my cab and use the facilities or not.

Jo: And if you're not wearing the right PPE, what would you do?

Usamah: Well at this site, me and Mo at the weighbridge go way back, so I would be happy to ask them to lend me a hard hat if mine was the wrong colour say. There's normally always loads of spare PPE if I really need it, but like I say, you can tell from the sign what's right.

Jo: That's great, thanks for that Usamah. Thinking about your drive onto site today, do you have any other safety concerns that we could discuss?

Usamah: Most days are the same, but I did see a car driving around today that looked lost.

Jo: Okay, so what did you do about it?

Usamah: Well I assumed someone would help them out, so I just kept doing my job. It was just a bit worrying 'cos some of the site isn't safe for small vehicles.

Jo: Do you think there is anything you could have done to help?

Usamah: I don't want to jeopardize my own safety so I'm not going to go chasing after some car on site when it's none of my own business. I meant to mention it to the security person on my way out.

Jo: Do you have a near miss reporting booklet in your cab?

Usamah: Yeah, it's here.

Jo: Well, would you mind doing me a favour? Before you leave today, will you fill out a near miss, describing the vehicle you saw and hand it to the weighbridge clerk, Mo? If you do that for me, I'll follow it up for security, would that be okay?

Usamah: Yeah that's easy enough. I'm seeing Mo next, I'll give it to him.

Jo: That's excellent. Thanks for your time both chatting to me and completing that near miss. Stay safe for the rest of your day.

Usamah: Yeah and you.



PPE

PPE is the last line of defense in all hierarchies of safety controls. However, where vehicle and pedestrian traffic is mixed, PPE in the form of High Visibility (Hi-Vis) clothing is essential. As well as ensuring pedestrians can be seen, Hi-Vis clothing is respectful to the drivers as it gives them an added layer of control to assist with hazard spotting.

Drivers always need to be wearing appropriate PPE, as they will often drive onto sites where, should they leave their cabs, they would immediately find themselves in hazardous environments.

There are different approaches to PPE regarding colour schemes and the use of reflective materials, which can be confusing. The MPA endorses research that shows:

- PPE should always provide 360° visibility
- Orange PPE provides greater visibility than yellow
- Reflective strips should be used to enhance visibility in the dark

Orange and red colours not often seen in nature so the orange PPE is much clearer than the yellow PPE shown here.



Questions every site should ask:

- Are there any opportunities to improve controls before relying on PPE, E.g. vehicle and pedestrian segregation?
- Who is likely to be exposed to traffic risks on site?
- Does the site have any vulnerable groups that require extra protection?
- Will pedestrians be performing tasks that require additional PPE?
- How are drivers and pedestrians made aware of the PPE rules on site?
- Is everybody appropriately trained in what PPE to wear and how to wear it?
- If required, is replacement PPE readily available?
- Is the PPE warning signage in the right place, up to date, clean and easily read?
- Is it easy for a driver or pedestrian to access PPE before being exposed to traffic risks? I.e. where is PPE stored?
- Does the PPE allow for changes in visibility?
- Does the business have appropriate KPIs in place to drive improvement in PPE compliance?
- How are PPE compliance and non-compliance reported?
- How do you promote best practice and reward compliance across the business?

Best Practice PPE - Operatives

Minimum Standards

Helmets normally less than 5 years old. Date of Manufacture should be found on all helmets and they should be of a good condition.

Sealed goggles are compulsory for loading/unloading of bulk powders. Safety glasses are usually compulsory for all drivers.

Hearing protection may be required on a site-specific basis.

Long sleeves are standard.

Safety gloves to the required BSEN standards are compulsory when undertaking a work activity.

High visibility overalls or jacket and trousers are best practice as endorsed by the MPA but alternative colour schemes may apply on a site-by-site basis. Ensure correct leg length.

Safety boots are compulsory. No rigger boots. Boots must be laced up (preferably with 150mm of heel support). Other means of protection are assessed by risk assessment.

Hi-Vis Clothing to EN471 Class 3 - High Speed Roads

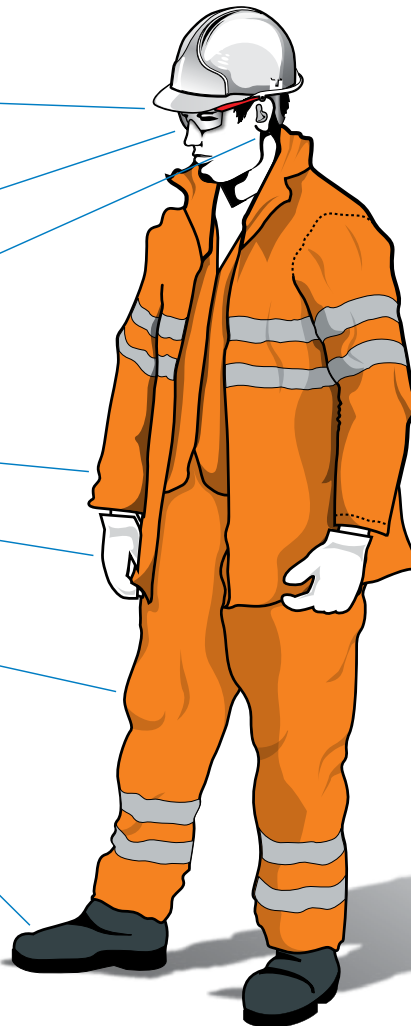

Best Practice

Best practice follows a standardised colour scheme e.g. green for first aid, red for traffic marshal. Additional features such as ID tags, high vis strips, halo band, head torches, updated head protection styles and "My Zone" proximity systems can all be utilised when risk suggests they are appropriate.

Goggles can also come with anti-mist or anti-scratch features, which would be appropriate for longer use or use in gritty areas.

Personalised hearing protection takes advantage of moulded ear plugs, whereas advanced technologies such as noise-cancelling head phones and intercoms are also increasing safety.

Chinstraps are considered best practice when working at height.

LED flashing jackets or lit jackets such as FHOSS increase visibility, whereas flame-retardant, anti-static, heat resistant, and electrical arc flash protect from specific hazards. Updated technology can also utilise body cams.

Best practice suggests banded above knee, intergrated knee pads, whereas flame-retardant, anti-static, heat resistant, and electrical arc flash protect from specific hazards.

Options include metatarsal, integral tongue, heat resist, water resist, or chemical resist as the environment dictates.

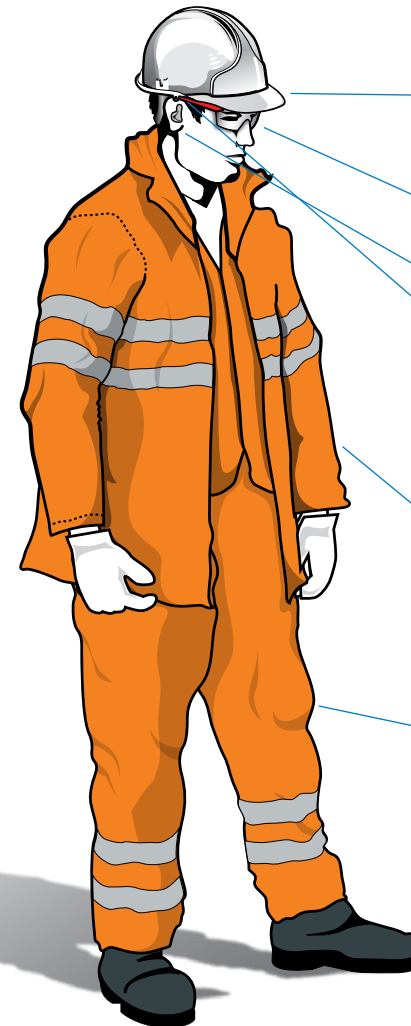

Best Practice PPE - Ex Works / Collect Customers

Minimum Standards

Helmets normally less than 5 years old. Date of Manufacture should be found on all helmets and they should be of a good condition.

Sealed goggles are compulsory for loading/unloading of bulk powders. Safety glasses are usually compulsory for all drivers.

Hearing protection may be required on a site-specific basis.

Chinstraps are considered best practice when working at height.

Long sleeves are standard to avoid risks of asphalt and cement burns and use of acid where used for readymix vehicle cleaning.

Safety gloves to the required BSEN standards are compulsory when undertaking a work activity.

Orange overalls or jacket and trousers are best practice as endorsed by the MPA but alternative colour schemes may apply on a site-by-site basis.

Hi-Vis trousers are best practice but some sites will allow alternative safety trousers.

Safety boots are compulsory. No rigger boots. Boots must be laced up (preferably with 150mm of heel support). Other means of protection are assessed by risk assessment.

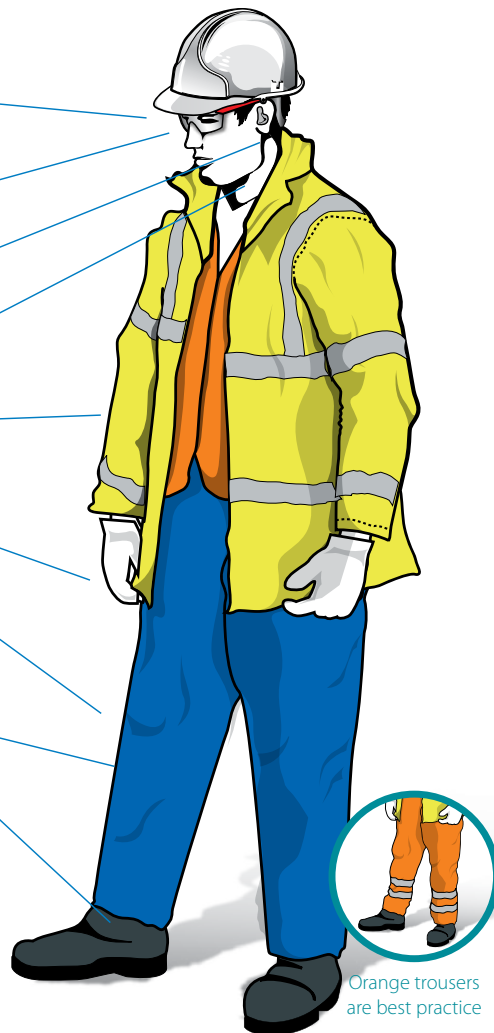

In the ideal world, we as an industry would like the customer's driver picking up their materials to be dressed in exactly the same standard PPE as those who put the product on to their vehicle, but the reality is somewhat different.

Collect customers, sometime known as "ex-works" customers, can be a challenge for our operational sites.

As they may not have come into contact with this industry before - or operate to standards different from ours - it can be somewhat difficult for site managers to both comply with the requirements of their company procedures and policies whilst serving the customers needs.

One of the classic examples would be the provision and use of PPE. Frequently there may be the problem of the customers driver not conforming to the PPE policy of the site.

There are various ways of dealing with this and some companies may restrict the driver to the cab. In practical reality though we should both advise the driver and the customer directly to ensure the driver comes fully prepared with the correct PPE next time.

As some products need to the driver to exit the cab, weighbridge or sales office staff commonly have a "reserve" stock of PPE that can be issued out to the driver and returned after the loading process is complete.

Though there are many ways of reducing the risks, collect drivers are likely to be a continual issue for the industry as a whole and therefore each site has to have a method of dealing with this situation in a proactive manner.



PLAN	DO	CHECK	ACT
Identify the PPE needs of the business. REMEMBER – too much unnecessary PPE will increase non-compliance.	Issue PPE that best meets the needs of the PLAN. "One Size" may not fit all so consider a holistic approach that incorporates distribution, training, communication etc. to best address the business's risks.	Performance is measured by compliance or non-compliance compared with incident reports. Utilise VFL to understand non-compliance and praise compliance to encourage best practice.	Take action on what was learnt through this PDCA cycle. Involving drivers and pedestrians in the next cycle by workshopping solutions based on the initial results will often result in increased compliance.

Drugs and Alcohol at Work

All MPA members require employees and contractors to be able to properly perform their duties unimpaired by the effects of drinking alcohol or taking drugs. MPA members aim to eliminate alcohol and drug misuse in the workplace by increasing employees' and contractors' awareness of its dangers.

- ✓ **DO** - Promote a culture in which alcohol and drug misuse is discouraged.
- ✓ **DO** - Ensure that employees' or contractors' use of either alcohol or drugs does not impair the safe and efficient running of the organisation, or result in risks to the health and safety of themselves, colleagues, customers and the general public.
- ✓ **DO** - Be aware that in the event of an individual failing an alcohol or drugs test, or refusing to take a test, the individual will be permanently excluded from site. The contractor could be deemed in breach of their contract.
- ✓ **DO** - Be aware that MPA member managers have the right to prohibit any person or activity on-site should they suspect alcohol or drug misuse, even if they are unable to instigate testing.



Drugs and Alcohol at Work

Alcohol

- ✗ **DON'T** - Drink alcohol or be under the influence of alcohol at work.

Remember that drinks the night before can still be in your system the next day, putting you over the limit. Where there are local rules in force governing the limit of alcohol that are stricter than those contained in the policy, the local rules shall take precedence.

Some delivery sites may have local limits that are below the drink drive limit.

Drugs

- ✓ **DO** - Be aware that, as a driver, prescribed or over-the-counter medicines may affect your ability to drive. As an employee, that may mean that you need to inform your manager or supervisor.

A list of common drugs that can affect your driving can be found via the reference section of this document.

- ✓ **DO** - Complete a drug test if you are asked by an MPA member company to do so .
- ✓ **DO** - Ask for the Company Policy if you wish to learn more about the MPA member's stance on drugs and alcohol.

- ✗ **DON'T** - Consume substances of any kind (including legal highs or prescription drugs) that may impair your ability to drive either on site, in company vehicles or before coming onto site.

- ✗ **DON'T** - Offer drugs or medication to colleagues.

Eligibility to Drive

Eyesight Checks

You **MUST** be able to read a vehicle number plate, in good daylight, from a distance of 20 metres (or 20.5 metres where the old-style number plate is used). If you need to wear glasses (or contact lenses) to do this, you **MUST** wear them at all times while driving. The police have the power to require a driver to undertake an eyesight test.

It is recommended that you get your eyesight checked at least annually (six-monthly if a member of the Fleet Operator Recognition Scheme (FORS) or equivalent scheme) to ensure capability to drive legally. FORS requires drivers to pass eyesight checks at 25m.

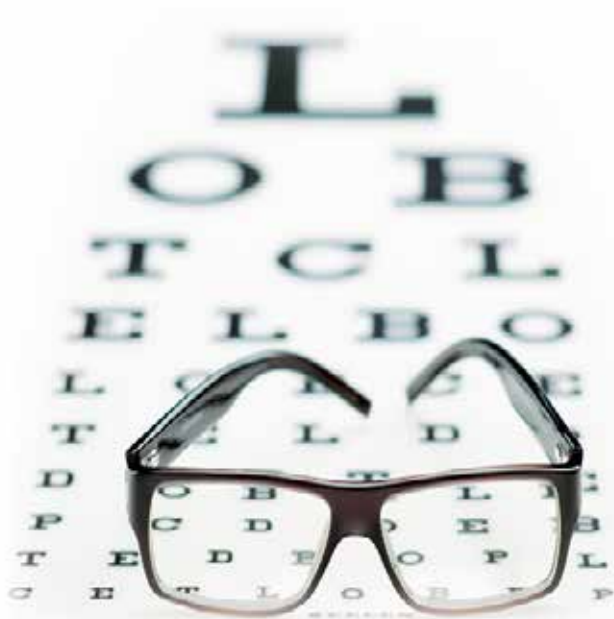

Fitness and Health

Staying fit and healthy is important to maintain a good quality of life as well as ensuring that you are fit to drive and carry out your job. If you have any health conditions that affect your driving you must advise your employer and inform the DVLA immediately. Failure to do so may lead to your license being revoked by the Traffic Commissioner.

- ✓ **DO** - Schedule set times for food.
- ✓ **DO** - Schedule in a daily exercise plan.
- ✓ **DO** - Opt for healthier food options and maintain healthy meal sizes.
- ✓ **DO** - Snack to a schedule on healthy options such as fruit, nuts or protein bars.
- ✓ **DO** - Consume plenty of water and ensure it is always available in your cab.
- ✓ **DO** - Regularly wash your hands, especially before eating.
- ✓ **DO** - Get plenty of rest. The amount of rest is mandated by your Working Time Directives, but ensure you are using this time to recuperate.
- ✓ **DO** - Replace lost vitamins, preferably by eating fruit and vegetables but alternatively through a course of vitamin supplements.
- ✓ **DO** - Keep your mind active. Listen to audio books, learn a new language or try different music genres in order to stimulate your mind and alleviate boredom.
- ✓ **DO** - Stay connected with home by catching up with family on your breaks or sharing experiences with family.
- ✓ **DO** - Be aware that some sites may require a fitness to work certificate to demonstrate compliance with specific local site procedures.
- ✗ **DON'T** - Eat or drink whilst driving.

Understanding Competence



Training

Training is an asset to a business as well as to an individual. By ensuring that a workforce is 'competent', a business can take advantage of those individuals who already possess several skills and enable those who don't to acquire them as a part of their personal development. Effective training will improve not only the safety, but also the quality and efficiency of any work done while reassuring workers that they are valued by the company, leading to improved staff retention rates.

A well-rounded approach to training will utilise a 'competency framework'. A successful competency framework should see the following results:

- A reduction in incidents and near misses through poor competence
- An increase in production
- An increase in management trust
- A reliance on the framework to underpin employee reviews/appraisal
- Provide better analysis of training needs
- Show enhanced career management

Competency Matrix				Required Completion Date											
Role:	Driver	Signed off by		Completion Date											
Employment Start Date:	Feb 20##	Date		Year 1											
				Jan	Feb	Mar	Apr	May	June	July	Aug	Sept	Oct	Nov	Dec
Qualification	Required Completion Date	Signed off by	Date												
Base Competency required for Employment															
DVLA Valid Driver Licence	Upon Employment	J. Bloggs	Feb 20##	■											
Driver Qualification Card	Upon Employment	J. Bloggs	Feb 20##	■											
MP Skills SSA & SUD or Equivalent	Within 6 months Employment	J. Bloggs	July 20##											■	■
Business Induction	Within 3 months Employment	J. Bloggs	April 20##				■	■	■						
Business Trained	Within 3 months Employment	J. Bloggs	March 20##			■	■	■							
Premium Competency schedule															
Industry Skills	Within 9 months Employment						■								
FORS/CLOCS standards and Requirements	Within 9 months Employment													■	

Job training matrix

Best Practice Training

Questions every site should ask:











- What is the definition of 'competency' for the role being undertaken?
- Is there a competency framework in place to set out and define competency for every role?
- How is training carried out within the business?
- Is the training relevant to the business?
- Is training presented in the correct format or could technology, professional coaches etc. offer a more appropriate delivery?
- Does the training enable an individual to see opportunities for progression?
- How are training requirements as well as optional opportunities communicated?
- How are individuals assessed?
- How often does training need renewing?
- Where are personal training logs stored and how are they accessed?
- What tools and resources are made available to individuals following training?
- Does training address 'soft' skills such as communication and leadership in addition to 'hard' technical skills?
- Is it appropriate for training to be conducted in-house or would it be more beneficial to bring in external training providers?
- Does any of the training need to be associated with specific certification or award bodies?











Best Practice Training



PLAN	DO	CHECK	ACT
Establish a competency framework to set out and define the competency for key roles.	Roll out training to relevant individuals, ensuring competency is assessed, recorded and a renewal date set.	Once training is in place, utilise VFL to sample individuals, covering their engagement and retention of the training as well as their understanding of potential future progression in line with the PLAN's competency framework.	Use the results of the initial scope to broaden the competency framework in terms of content and individuals in attendance.

Training

Employees	Contractors
 Construction Skills Certificate Scheme	 Construction Skills Certificate Scheme
 Highways England Passport Scheme	 Avetta Contractor Prequalification and Compliance Management
 Construction Industry Training Board (CITB) Construction Plant Competence Scheme	 Highways England Passport Scheme
 Vehicle Banksperson Training	 Quarry Passport Scheme
 MPQC Plant Operator Competency Scheme	 CITB Construction Plant Competence Scheme
 MPQC Vocational Qualifications	Partner Operated (POP) Scheme

Drivers	Managers
 Drivers Skills Card	 Visible Felt Leadership
 Mineral Products Qualifications Council (MPQC) Standards	 National Examination Board in Occupational Safety and Health (NEBOSH) HSE Certificate in Health and Safety Leadership Excellence
 Certificate of Professional Competence	 HSE recognised Sector Specific Vocational Qualifications.
 Vulnerable Road User	 SHE VQ/NVQ Qualifications.
 Vehicle Banksperson Training	
 Safe Urban Driving	

Safe Behaviours and Expectations

While every business can put processes and equipment in place to drive the health and safety of its people, the individual behaviour of its people also needs to be managed in order to achieve its health and safety aims.

Half of the focus on vehicles and pedestrians - the pedestrians - are people and the other half - the vehicles - are driven, operated and maintained by people.

Encouraging positive safety behaviours and setting high expectations can empower everyone in the business to keep themselves and others safe.

Managers should ensure active employee involvement in pedestrian/vehicle segregation plans.

Pedestrian separation associations	
Primary risk	To pedestrians being struck by forward moving and reversing powered vehicles
Main management deficiencies	Risk assessment and its implementation (80%) Monitoring and detecting/correcting unsafe behaviour (60%)
Key behavioural issues for pedestrians and drivers	Key workplace and vehicle issues
<ul style="list-style-type: none"> • Inappropriate action by pedestrian site employees (51%) • Driving without due care and attention (48%) • Not following established statement of work (SoW) (25%) • Selection of inappropriate route (20%) 	<ul style="list-style-type: none"> • Separation of vehicles from pedestrians (71%) • Areas of specific hazard to pedestrians (50%) • Traffic routes (43%) • Designated manoeuvring areas (33%) • Reduced driver visibility due to workplace layout (28%) • All-round visibility from the vehicle driving position (40%) • Vehicle warning devices (19%)

Note: Where the actions of pedestrian site employees are an issue, pedestrian workplace transport awareness training could be considered.

Questions every site should ask:

- What are the business values?
- How does the business communicate its safety values and do management reinforce when on site visits?
- How does the business recognise and share best practice?
- How are key learnings from mistakes communicated to the wider business?
- What processes are in place to enable a dialogue between the workforce and the management team?
- What expectations do employees have on the business to keep them safe?
- What triggers are in place to encourage people to follow through with the behavioural expectations of the business?
- Is the workforce empowered to challenge unsafe behaviours?
- Is the workforce encouraged to stop work that isn't safe or which they don't believe to be safe?
- Is safety treated with the same time and respect as any other business risk by everyone in the business?
- Is time taken to establish root cause following an incident or near miss and communicated to sites to show them how to improve?
- Is the management trained to address complacency, frustration, rushing and fatigue to the same level as other safety processes?
- Are people within the business given the opportunity to develop their safety knowledge?

Case Study

Safe Behaviours and Expectations

Core Safety put together a clear and comprehensive guide to Safety Behaviours and Expectations that lays out the commitment not only from employees, but also from the business itself when it comes to safety behaviour. This communication respects the workforce and enables them to challenge their peers and the business itself when the highest safety standards are not adhered to.

Safe Behaviours and Expectations

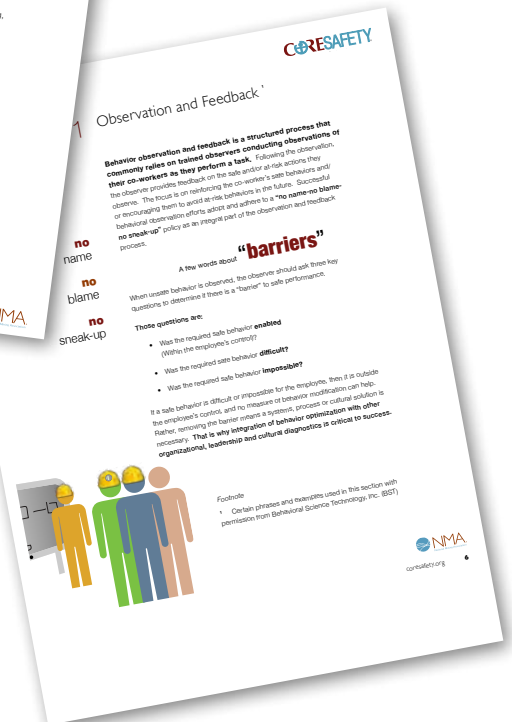
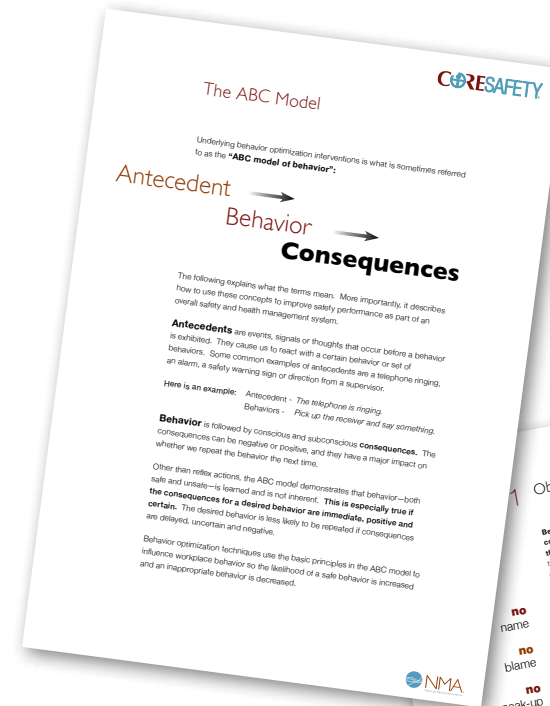
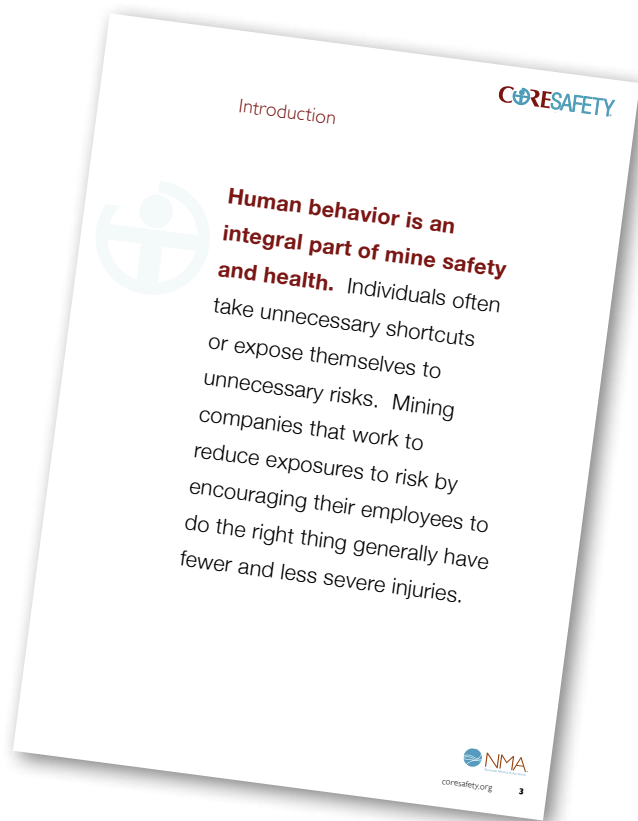



Plant Safer by Design

Safer By Design

The most effective way of improving our health and safety performance is to eliminate high-consequence hazards at the design stage; it is therefore vital to purchase, operate and maintain plant and equipment that does not place the health and safety of employees, contractors or third parties at risk.

Analysis of incidents involving fatalities or serious injuries has revealed that, in many cases, poor plant design was a major factor. While the plant met both the statutory requirements and international standards, it still exposed individuals to avoidable, high-consequence hazards. Unfortunately, the inherent time lag in the process for changing standards means that H&S features on most plant sold as 'standard' by manufacturers does not conform to what is recognized as current best practice.

Safer by Design is voluntary guidance that has been developed to address the failure of standards to reflect current best practice. It has been produced by health and safety experts working within the mineral products industry, and outlines the key health and safety features recommended to be incorporated into plant that is operated within the industry.

The benefits of Safer by Design are as follows:

For the mineral products industry:

- Helps us improve our H&S performance
- Fewer plant related fatalities and serious injuries addressing 'The Fatal 6' concerns
- More efficient plant that is easier to operate and maintain
- The environmental impact of plant is reduced
- It is regularly reviewed and updated by experts
- Manufacturers supplying plant with improved H&S features
- Free and easily accessible via the Safequarry and Safeprecast websites.

For employees and contractors:

- Plant that is safer and easier to operate and maintain
- Plant that does not expose operatives to health risks
- Improved ergonomics and comfort in the work environment
- A safer and healthier environment for all on site
- Reduced risk of accidents on the highway or customers sites
- Safer for third parties who interact with employees or contractors.

For buyers and site managers:

- Ability to specify plant that reflects best practice in industry
- Ability to compare H&S features of different manufacturers
- Easily generated specifications from Safer by Design
- Ability to audit how well existing plant meets Safer by Design standard
- Ability to generate reports for internal use
- Manufacturers providing more H&S features as standard
- More warrantied H&S options available from manufacturers.

For manufacturers:

- Clear understanding of industry-wide consensus on H&S features required
- Ability to improve competitiveness of their plant by meeting Safer by Design
- Option to promote plant H&S features via the Safer by Design platform
- A source of expert market feedback on H&S features
- Increased demand for H&S features that may be developed as extra.

Plant Covered By Safer By Design

As an ongoing project,, Safer by Design will be expanded to cover five different types of plant. Currently, it incorporates mobile plant, and mobile crushes and screens.

1. Mobile plant
2. Mobile crushers and screens
3. Contract surfacing plant
4. Fixed plant
5. Large goods vehicles (LGVs)



'The Fatal 6' and Key Issues Covered By Safer By Design

The table below illustrates the five key areas of health and safety that the Safer by Design reports address. The table illustrates how these areas impact on the themes identified in 'The FATAL 6'.

'The FATAL 6'		Access Systems	Visibility	Safety and security	Maintenance	Environment and Health
1	Contact with moving machinery and isolation			✓	✓	
2	Workplace transport and pedestrian interface		✓	✓		✓
3	Work at height	✓			✓	
4	Workplace Respirable Crystalline Silica					✓
5	Struck by moving or falling object				✓	
6	Road Traffic Accidents		✓	✓	✓	✓

By adhering to the voluntary Safer by Design guidelines and operating plant that meets this standard, significant improvements will be made in the reduction of injuries and fatalities that fall within these six themes.

Accessing Safer By Design

Safer by Design is accessed via the Safequarry and Safeprecast websites. The content is free to access. The web pages incorporate easily downloadable pages and reports for users. A short video, which provides an overview of Safer by Design, is also accessible via the website.



Safer By Design and International Standards

Safer by Design is supportive of the European and International standards and the systems that are in place for their management. These systems are necessarily cumbersome and produce standards that fall short of the ‘state of the art’ claimed to be represented by the CE mark. Research has shown that a significant proportion of incidents involving mobile plant on mineral producing and processing sites are due to poor design. The plant involved meets the international safety standards and the requirements of the EU Machinery Directive and, where applicable, the EU Outdoor Equipment Directive. However, they fail to provide the mitigation of hazards that the UK Mineral Products Industry now demands.

‘Safer by Design’ is managed by the MPA and enjoys wide-ranging and ever-expanding international tripartite support.

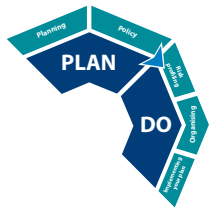

Vehicles

The “MPA Delivery Drivers Handbook” highlights the common vehicle standards required to complete a thorough safety vehicle check from the driver point of view.

Many of the vehicle checks which would have been considered best practice when the Delivery Drivers Handbook was first conceived, is now a minimum standard if not a legal requirement.

With the focus on improving transport safety between vehicles and pedestrians, this guide looks to raise the standards once again, holding them up against the current minimum and legal requirements so that any organization can see where they are starting from and work to get to a place of best practice within the range of their risk profile.

The following vehicle standards are applicable to road, site, contract surfacing and ancillary vehicles, putting Safer By Design first and prioritizing the safety of vulnerable road users in the situations they are likely to come into contact with these vehicles.

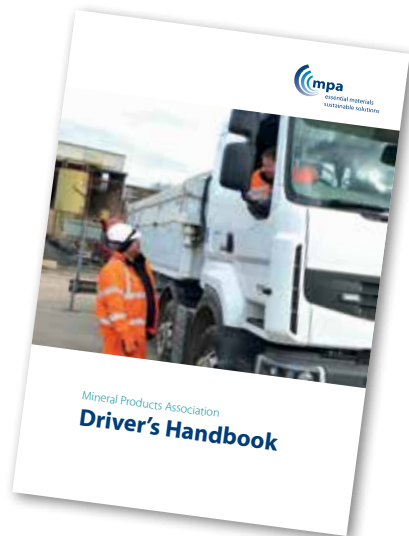

Road Transport

Legal Requirements	Basic Standards	Innovation Moving Forward
Vehicle must comply with C&U regulations, using visual aids including all mirrors and/or CCTV	Side proximity sensors and/or nearside cameras	360° CCTV recording system
Roof-mounted amber beacon or two 360° flashing amber lights	Reversing CCTV	"Optimum direct vision cab. If older vehicles, retrofit direct vision nearside door window"
Vulnerable road user warning sign	External pictorial markings warning of high risk areas on vehicle	"Sensor system alerting drivers of collision risk (mandatory in certain urban areas including London)"
Handrails for three points of contact	Audible left turn warning sound	Near side cab window
Reversing Alarm	Loading camera	Radio mute when reverse gear is selected
Side under-run protection	'Hold on/Get a grip' signs	Onboard incident recorder
High visibility livery in line with Chapter 8 requirements		Hand brake sensor
		Seat belt sensor
		Driver telematics
		LED blind spot light
		Radar obstacle detectors
		Automatic braking controls
		Automatic banksman controls

Vehicle Standards

Optional Vehicle Accessories

Hi-Vis Livery

All vehicles stopping on the highway for works purposes or inspections shall:

- Be equipped with Hi-Vis rear markings
- Should be of a conspicuous colour (e.g. yellow or white). A non-reflective yellow colour, No. 355 (lemon) is recommended.

Hi-Vis rear markings should comprise either:

- Chevron markings comprising alternate strips of retro-reflective grade orange-red retro-reflective material and fluorescent yellow non retro-reflective material of not less than 150mm width each, inclined at 45-60° to the horizontal and pointing upwards
- A solid block of fluorescent orange-red retro-reflective material. These markings should cover as much of the rear-facing portion of the vehicle as possible without obscuring windows, vehicle lighting or registration plates
- In addition, maintenance vehicles must display "HIGHWAY MAINTENANCE" text. This text must be a minimum of 70mm high for temporary traffic management vehicles and 140mm for all other vehicles carrying personnel or equipment
- A strip of micro-prismatic grade material that is a minimum of 50mm wide must be fitted along either side of vehicle whilst red retro-reflective tape shall also be applied to all rear-facing edges of open doors, guardrails and equipment lockers
- Where rear-facing Hi-Vis markings may be obscured by any device mounted on the vehicle, additional Hi-Vis rear markings shall be applied to any face of the device that is displayed to the rear and other road users.

DfT Guidelines on markings can be found in Chapter eight of the Traffic Signs Manual.

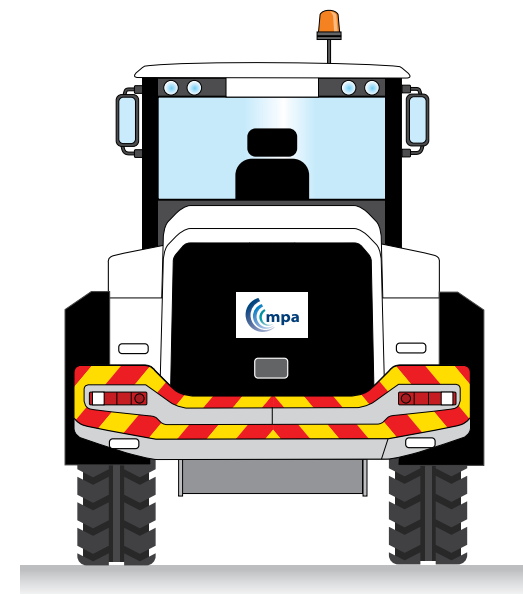

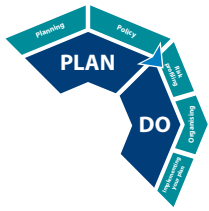

Road Vehicles

Tipper Vehicle

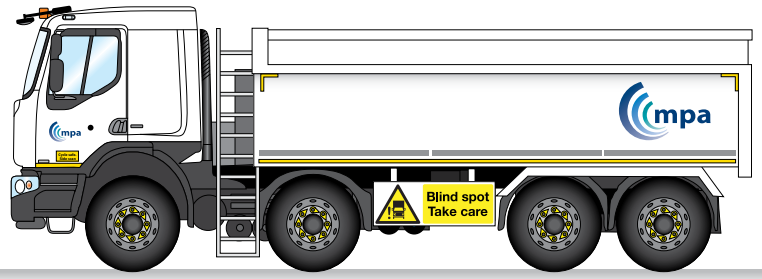

Flatbed Vehicles

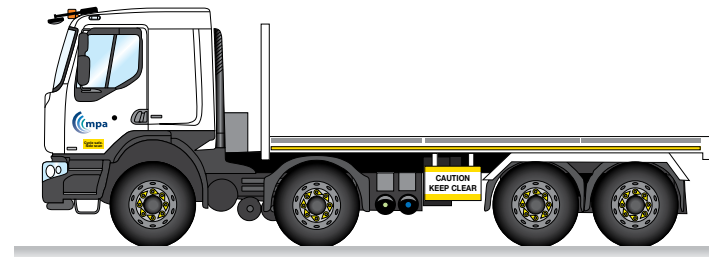

Bulk Powder Vehicle

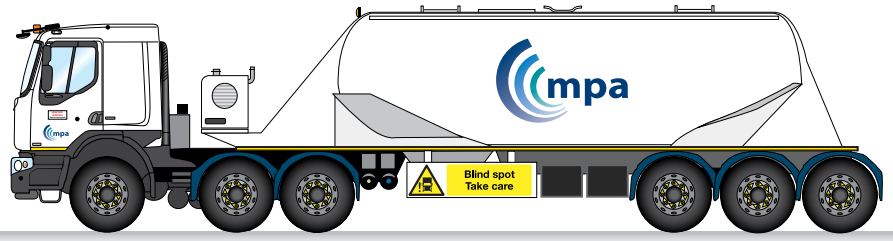

Low Loader Vehicle

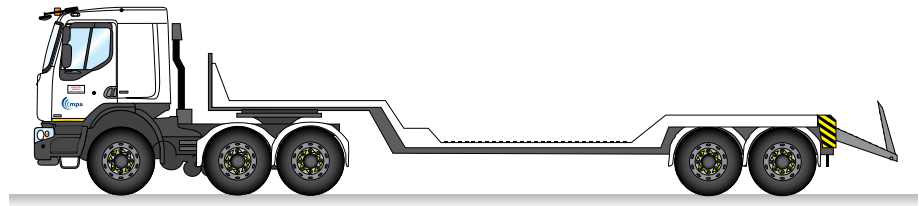

Volumetric Vehicle

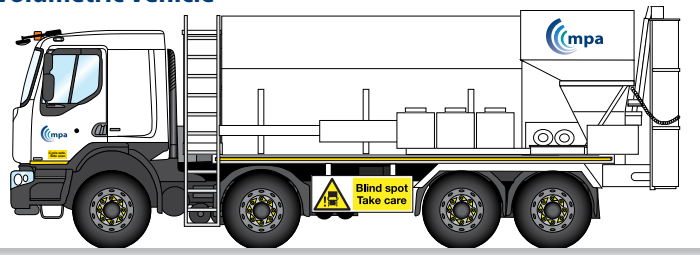

Flatbed & Crane Vehicle

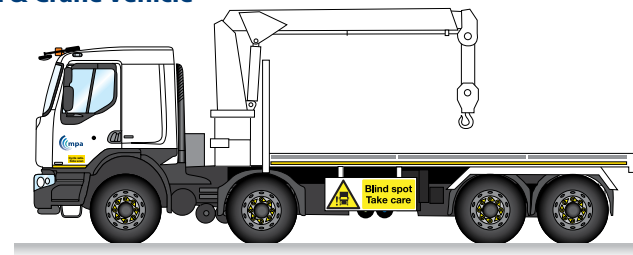

ALL DELIVERY VEHICLES MUST BE CLOCS COMPLIANT OR EQUIVALENT

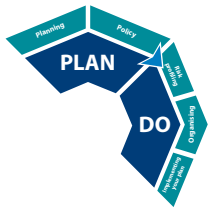

Road Vehicles

Curtain Siders Vehicle

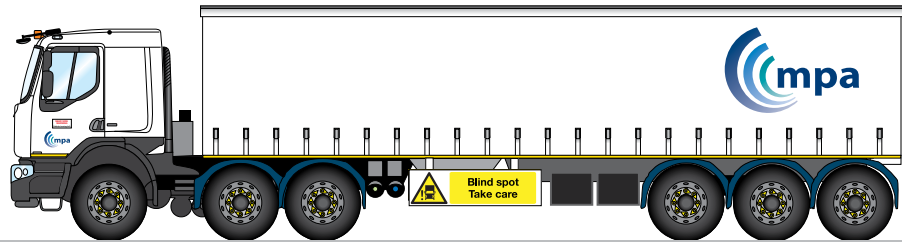

Mixer Vehicle

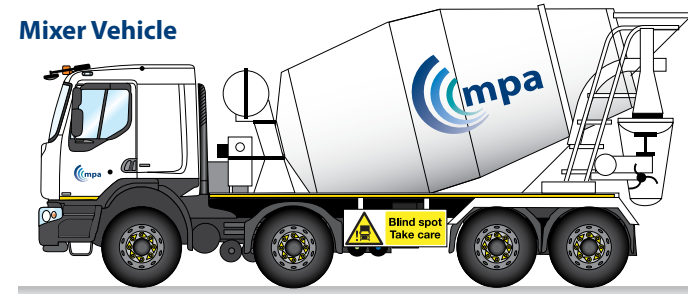

Walking Floors Vehicle

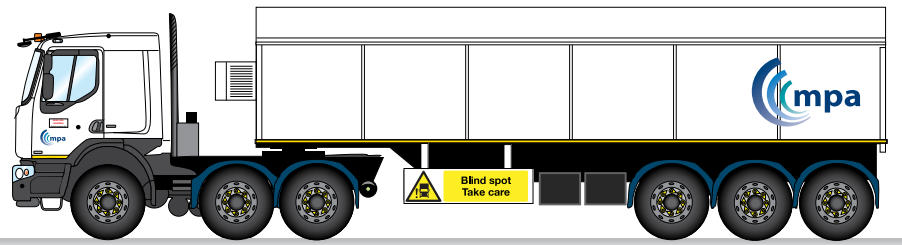

ALL DELIVERY VEHICLES MUST BE CLOCS COMPLIANT OR EQUIVALENT

Common Standard for Aggregate and Asphalt Tipper Vehicles - LGVs

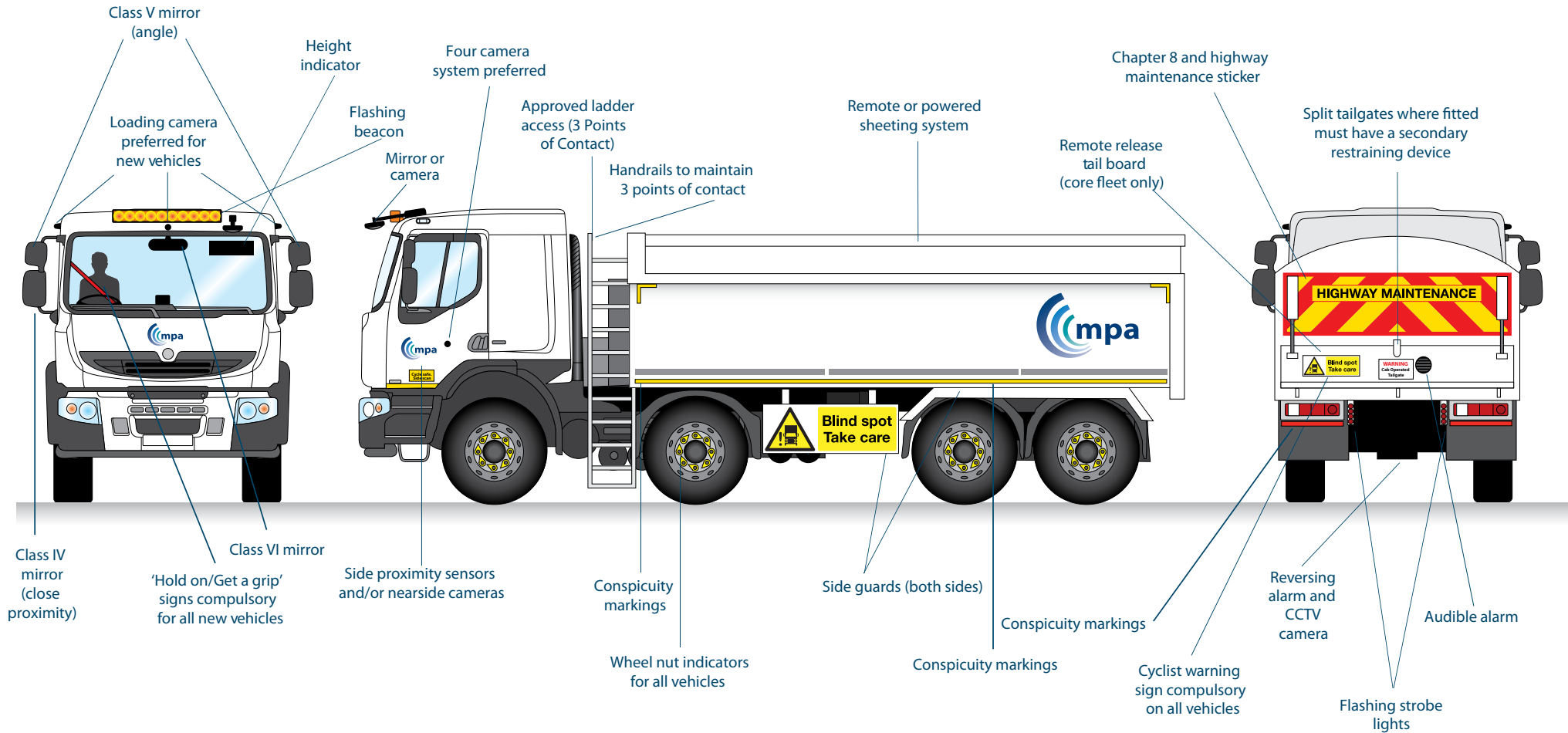

Vulnerable road user preferred options:
 Front - Optical VRU Detection System

Visability Zones

Good direct vision

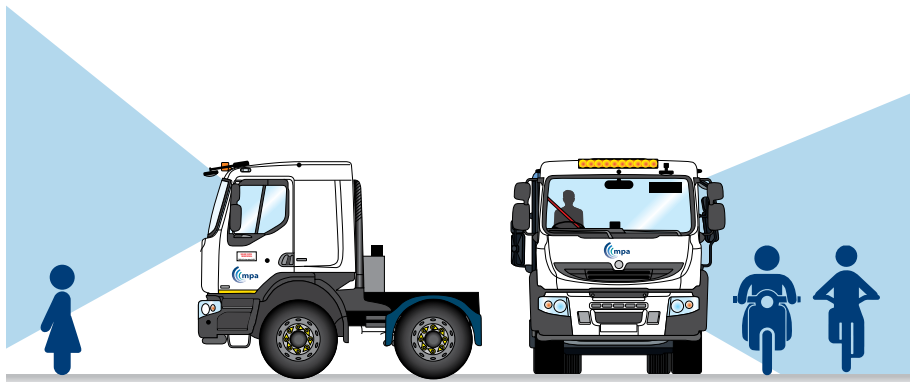

Poor direct vision

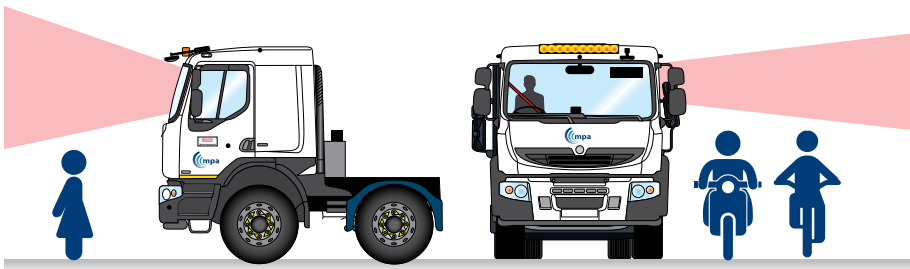

HGV star rating boundaries

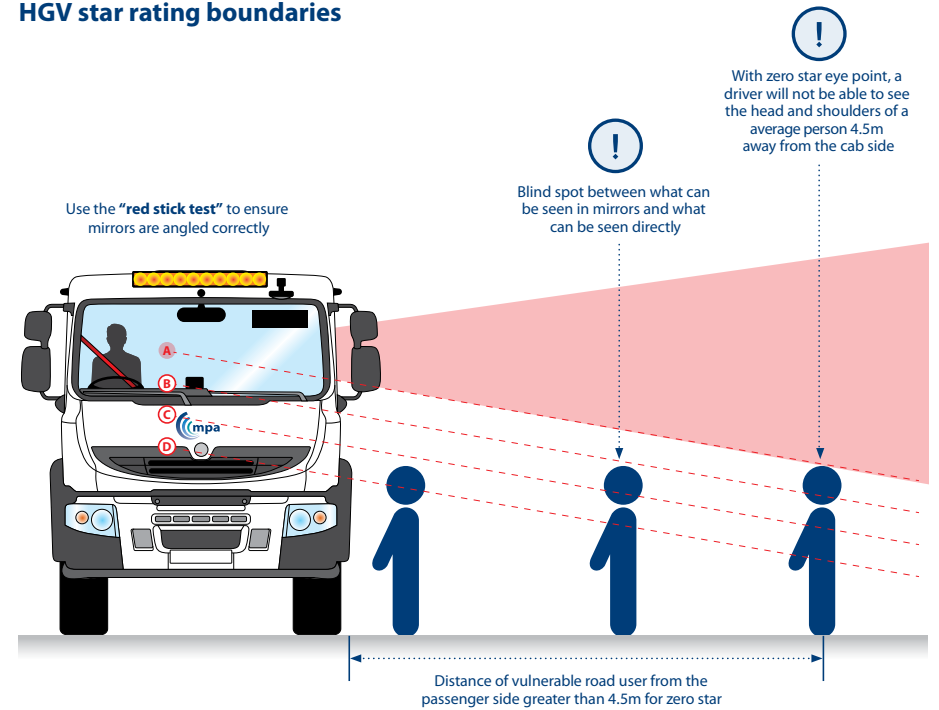

Star rating	Description
A	Zero star eye point
B	One star eye point
C	Three star eye point
D	Five star eye point

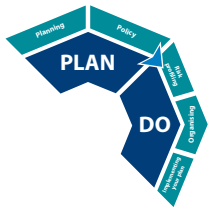

Site Vehicles

Loading Shovel



Dozer

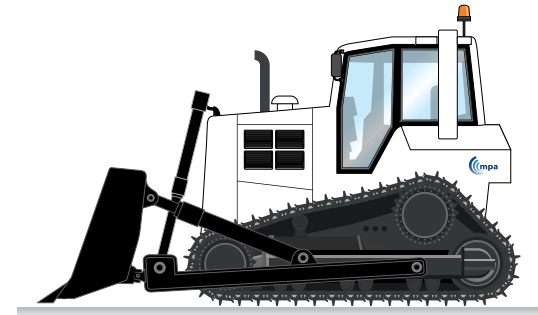

Excavator

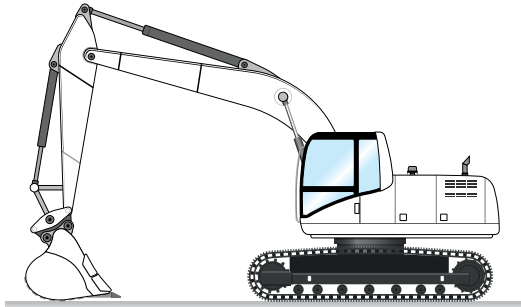

Articulated Dump Truck

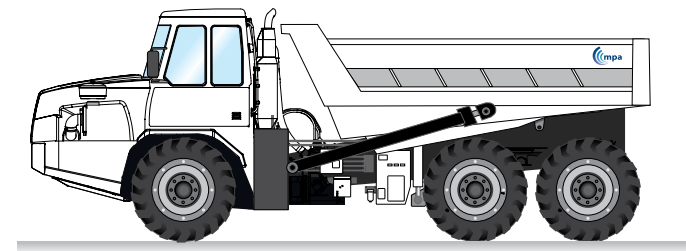

Dumper

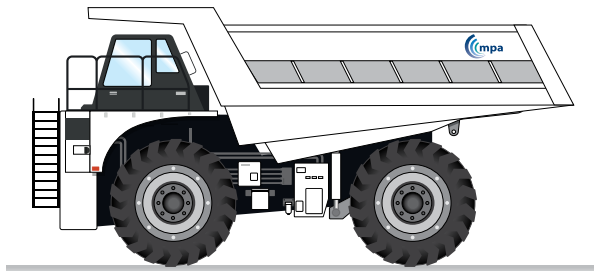

ALL DELIVERY VEHICLES MUST BE CLOCS COMPLIANT OR EQUIVALENT

Common Standard for Site Vehicles

Consider:

- Auto-stop functionality
- Stereoscopic human recognition camera
- Auto proximity detection
- Speed limiting of the plant

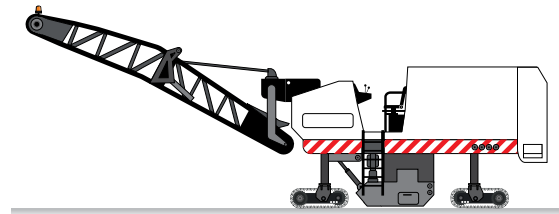
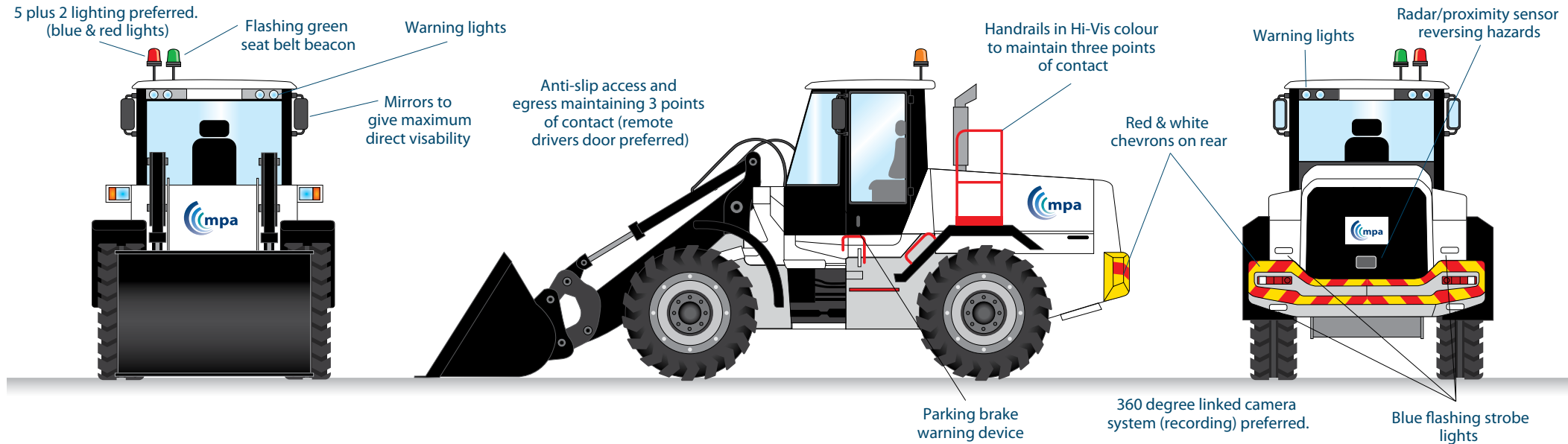

Planer

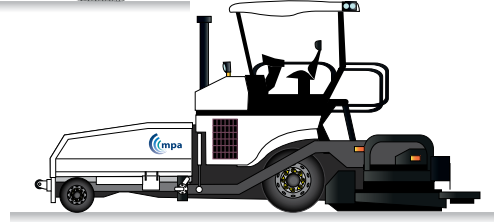

Paver

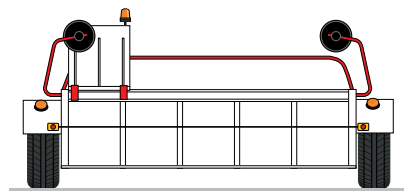

Chipper

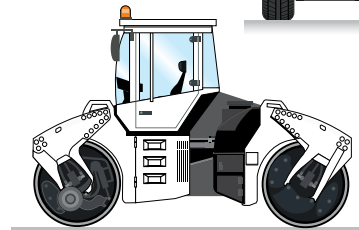

Roller

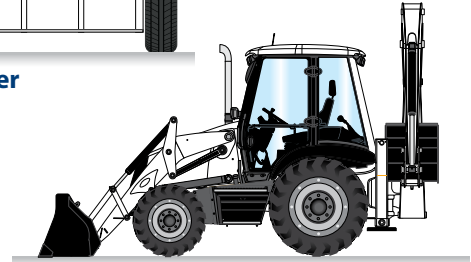

JCB 3CX

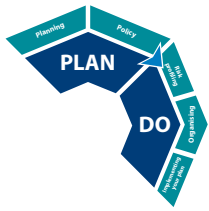

Ancillary Vehicles

Fork Lift Truck (FLT)
Grab Truck
Reach Truck
Rough Terrain Fork Truck



Skid Steer



Telehandler

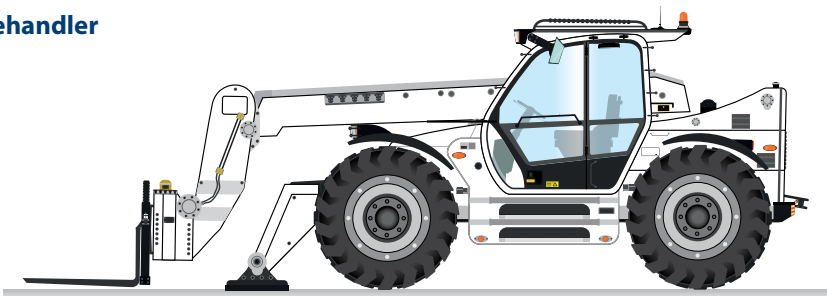

Tanker

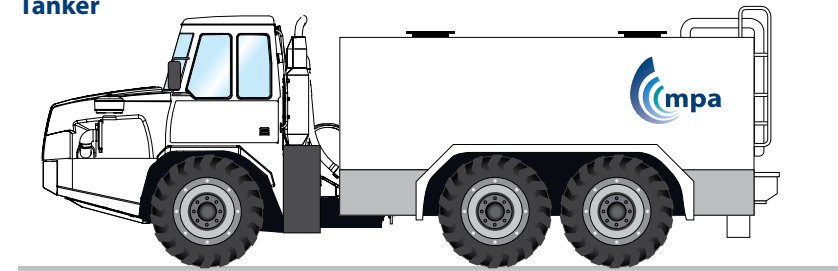

Cherry Picker

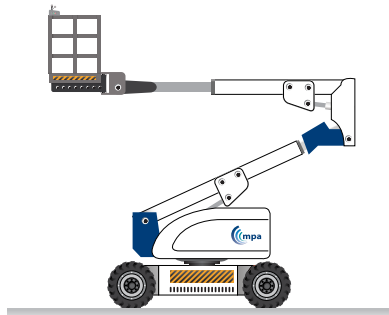

All ancillary vehicles on this page must have the following safety features:

- Red and green flashing lights
- Reversing alarm
- Proximity radar
- Seat belts
- Reversing CCTV
- Chapter 8 signage (where required)
- Appropriate mirrors to achieve 360-degree visibility
- Use of harness and lanyard in cherry pickers

Consider:

- Auto-stop functionality linked to either radar or stereoscopic camera
- Full recording camera system

ALL DELIVERY VEHICLES MUST BE CLOCS COMPLIANT OR EQUIVALENT

Vehicle Equipment

Vehicle equipment refers to basic or advanced technologies added to a vehicle in order to improve the safety of the person working with or around it.

This equipment can be separated into two types:

- 1) Equipment designed to assist the skills of a human operative.
- 2) Equipment designed to control the failures of a human operative.

Equipment designed to assist the skills of a human operative is effective as long as the person/s working with that vehicle do not make a mistake and utilise this equipment to the best of their abilities e.g. reversing alarms that alert pedestrians to the danger of a moving vehicle, which can still be ignored.

Equipment designed to control the failures of a human operative will prevent an incident or accident from occurring even if a person or people working with that vehicle fail to work in the safest way themselves e.g. reversing sensors that can stop the vehicle even if a pedestrian or driver ignores the danger of a moving vehicle.

A business' risk profile surrounding any task or environment will establish whether the first or second type is more appropriate, but there are several types of equipment that are mandatory and must be applied, well maintained, and checked before every use of the vehicle.

Best Practice Vehicle Equipment

Questions every site should ask:

- Where will the vehicle be working?
- Will this vehicle equipment function in all environments, e.g. adverse weather conditions or poor light?
- Who is at risk from the activity of the vehicle?
- Does the risk profile suggest equipment designed to control human failure would be more appropriate?
- Do the new vehicles being purchased have the mandatory equipment fitted? If not, consider options as to how to make the vehicle compliant.
- Have the older vehicles in the fleet been actively retrofitted with the mandatory equipment? If not, what is the plan for fitting these and to what time lines?
- Have all drivers been trained on how to best use the equipment fitted to their vehicles?
- What is the process for vehicle and plant checks before use?
- How quickly can a vehicle be made safe again if additional equipment is found to be faulty?
- What features are in place to prevent equipment from being defeated?
- How is the equipment on contractor vehicles monitored, managed and controlled?
- Has a suitable solution been put in place in line with the risk profile of the driving environment?

Example of Best Practice Vehicles Equipment

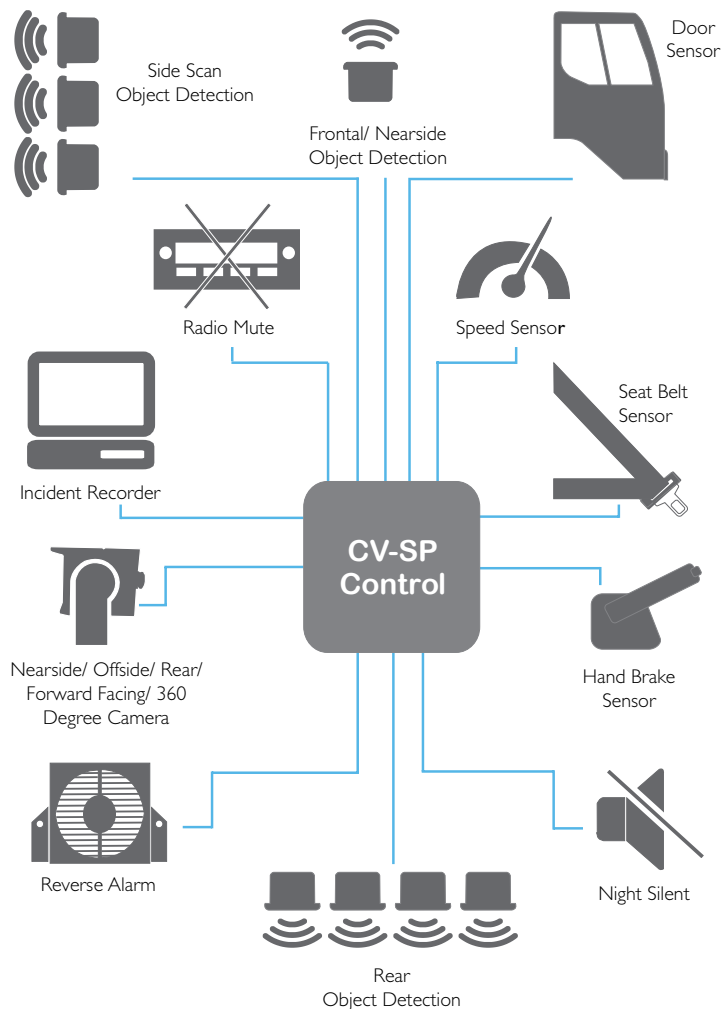

Courtesy of Spillard

Vehicle Equipment

Warning Lights

For highways work, vehicles must be fitted with an amber warning light bar comprising of at least two independent light sources. If this is not the case, vehicles must be fitted with two separate roof-mounted flashing amber warning beacons with either or both being visible through 360 degrees. If the main roof-mounted beacon is likely to be obscured from the rear by parts of the vehicle or any equipment carried on the vehicle, additional beacons should be fitted toward the rear of the vehicle where they remain visible.

The roof-mounted beacons should be used when entering, leaving or moving within a site. They should also be used when travelling in traffic at less than the general traffic speed and when stationary on the hard shoulder, unless they form part of the guarding of the works.

Flashing Strobe Lights

If the roof beacon cannot be seen it is important that the strobe lights are functioning, as these will be functioning as the warning lights.

Reversing Lights

These need to be checked and confirmed as working before the journey is started.

Exclusion Zone Lights

“5+2 Exclusion Zone Lights” encourage operatives to maintain an exclusion zone of two metres to the side and five metres front and back of the machinery. Blue LED lights create a square on the road to indicate to operatives where the exclusion zone is whilst the vehicle is operating.

Red warning bars are also commonly used around fork lift trucks and other ancillary vehicles. Neither blue nor red lights can be used on the highway where the public have access.



Vehicle Equipment cont...

Mirrors

Ensure all vehicles are fitted with mirror. Passenger-side blind spot mirrors are known as Class V and front-side blind spot mirrors are known as Class VI. All mirrors must be kept clean, appropriately positioned and free of defects.



Hi-Vis Livery

It is best practice for all vehicles stopping on the highway for works purposes or inspections to be equipped with Hi-Vis chevron marker boards. These should be of a conspicuous colour (e.g. yellow or white) and a non-reflective yellow colour, No. 355 (lemon) is recommended. Whilst these markings support visibility for other road users, they must be compliant with vehicle conspicuity marking regulations.



- Maintenance vehicles must display "HIGHWAY MAINTENANCE" text. This text must be a minimum of 70mm high for temporary traffic management vehicles and 140mm for all other vehicles carrying personnel or equipment.

In addition to this, all vehicles should have rear-facing signs for vulnerable road users, which need to be kept clean and visible, while side-facing "Blind" spot signs should be maintained on both sides.

LED Blind Spot Light

Some signs for vulnerable road users and 'blind spot' signs are now available with LEDs that flash when the vehicle is making a left turn. Whilst not mandatory, these can be particularly effective in heavily built-up city centres or during winter when evenings are darker.



Cameras

Rear CCTV needs to be fitted on any vehicle exceeding 3.5 tonnes, but 360-degree CCTV is also available to offer additional assistance to the driver in anticipating hazards in their blind spots.

Regardless of the type of CCTV being utilised, vehicles need to make people aware there is CCTV on board as a part of the Data Protection Act 2018. This is most commonly done with a label at the rear of the vehicle.



Alarms

There are two mandatory hazard alarms on all vehicles: the reversing alarm and the handbrake alarm. As technology develops, the sophistication of these alarms is advancing. The reversing alarm must come on automatically when the reverse gear is selected, which needs to be checked before a vehicle begins any journey (during the hours of darkness an alarm mute system may be necessary).



Radio mute systems can also be installed, which mute the radio when reverse gear is selected to minimize distractions to the driver when carrying out a reverse maneuver.

The handbrake alarm should sound every time the driver leaves the cab without the handbrake properly applied, regardless as to whether the engine is still switched on.

Additional alarms can also be fitted, such as a driver seatbelt alarm, indicating that the driver or their passengers are not wearing their seatbelts whilst the vehicle is moving. If any additional alarms are fitted it is important that these are checked on a regular basis. No alarms should be able to be disconnected or defeated.

Radar Obstacle Detections

To offer as many opportunities for drivers to understand their surroundings as possible, additional detection settings such as radar can be installed. This detects objects in the radar field and informs the driver either via a warning sound or visual dashboard. It adds another tool for the driver to use to increase their overall awareness of what is around them and their vehicle.

Telematics

Some businesses and their drivers can benefit from the installation of telematics, which can measure driving metrics such as speed, harsh braking, acceleration and steering. These tools aren't designed to replace tachographs - which are required for drivers' hours compliance - but can enhance the drivers' ability to understand their fuel consumption and effects on environment and overall quality of driving.

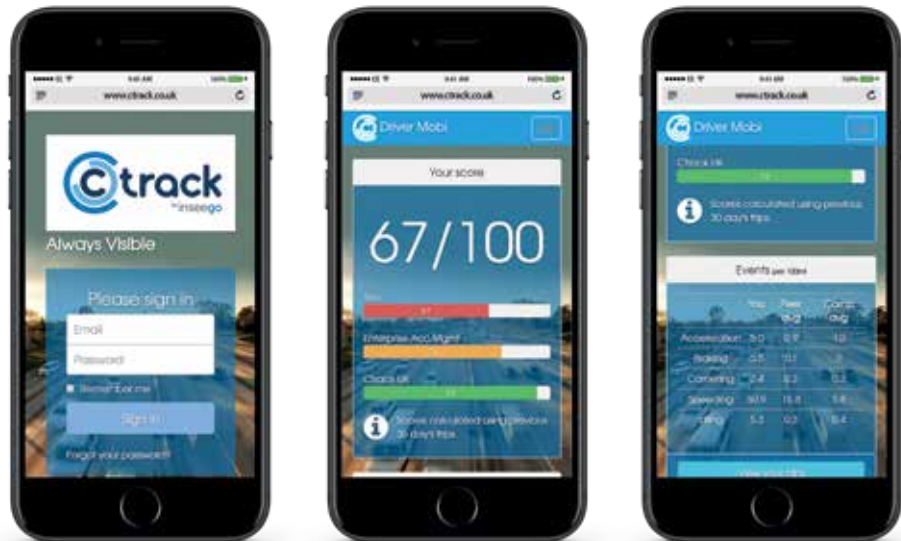

Courtesy of Ctrack Telematics Solutions

Active Controls

The final step in vehicle equipment is the application of devices that apply themselves without driver intervention. This means that if the driver makes a mistake, the vehicle is still safe.

- **Brakesafe** - Preventing runaway incidents with our automatic failsafe system that applies the vehicle handbrake if the driver attempts to leave the cab.
- **Stopsafe** - A new braking solution that allows the crew to bring the vehicle to a stop should the driver become incapacitated.
- **Banksman/vms** - FMCW technology detects and monitors moving and stationary objects with 100% accuracy. Its in-cab audible, visual alarms alert the driver of hazards, should the driver not respond to the alerts the system will bring the vehicle to a controlled stop.



Courtesy of Vision Techniques

Best Practice

Changing Weather

The UK experiences such a varied climate it is possible to seemingly experience all four seasons in one day. Each season can bring with it its own challenges, from dust on roads in summer to leaf fall and fog in autumn, and from freezing conditions in winter to soft ground as springs starts.

While extreme events are becoming more common and all businesses must start to factor these into the strategic thinking, the seasonal changes each year should not come as a surprise. By reviewing previous years' experiences, understanding past difficulties and assessing how they were managed, a business can repeat what worked well and look for opportunities for improvement.



Questions every site should ask:

- How have previous years' weather affected sites?
- Are there local conditions that prevail that are outside of the norm, e.g. western areas of the UK tend to be wetter?
- Do you have plans to deal with the issues each season brings?
- How will you communicate these plans to staff?
- Are areas of the site more prone to waterlogging, such as the low points of the site?
- Are wheel-wash facilities in place to minimise the risk of mud being drawn onto the public highway?
- Do you have enough materials on-site to deal with icy conditions in winter?
- How will you communicate to staff, contractors and hauliers if the site has to close due to inclement weather?
- How are weather forecasts monitored for storm events that may affect the site?
- Is the site at risk from surface water or tidal flooding? What plans are in place to deal with this risk?

Best Practice Weather Hazard Awareness Map

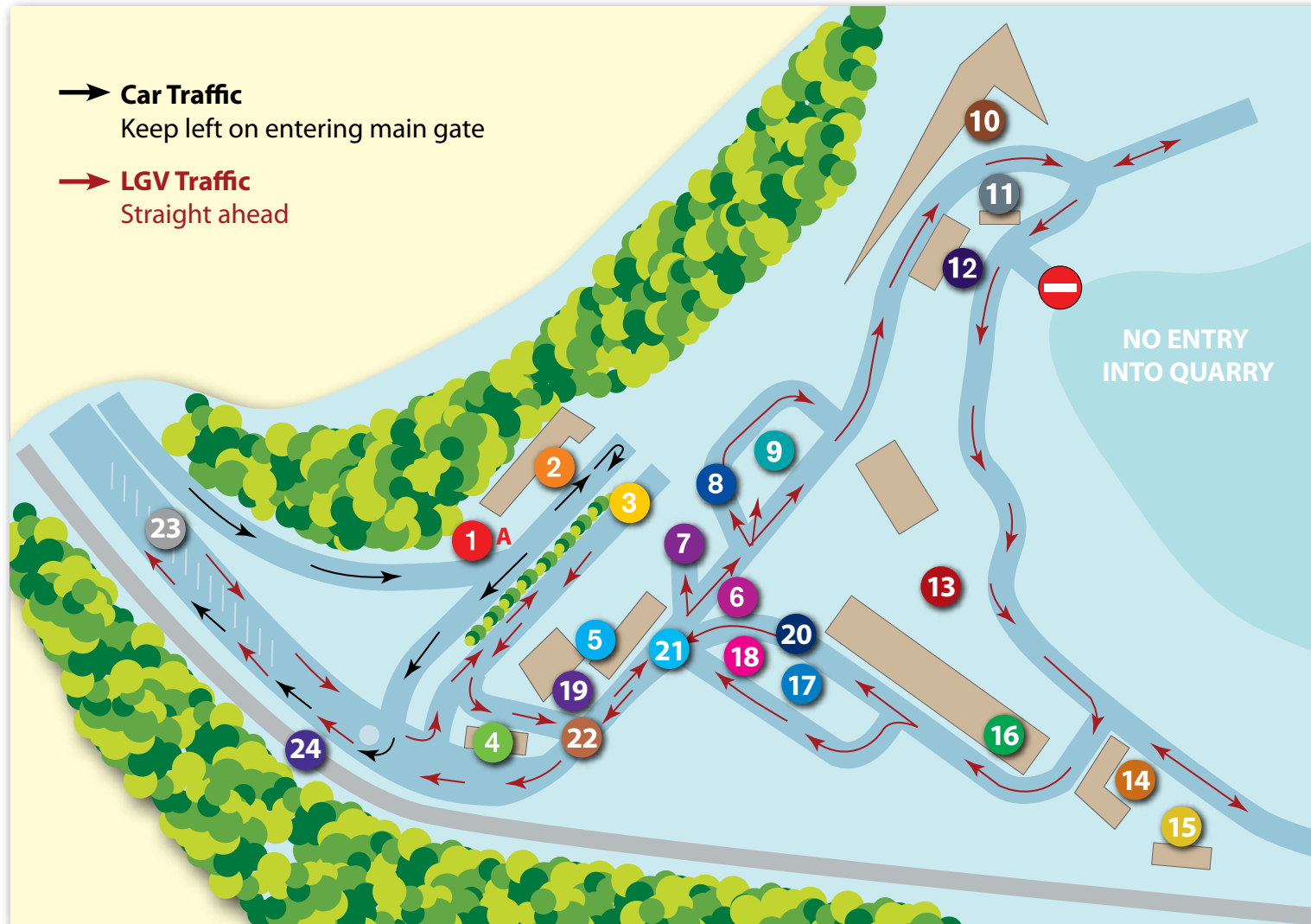

Key

- A** Assembly Point
- 1** Car park
- 2** Debris and leaf debris
- 3** Lorry holding area and diesel tank
- 4** Weighbridge
- 5** Dip in ground - Liable to flooding
- 6** Drainage convergence point
- 7** Sewage drain
- 8** Sewage drain
- 9** Quad
- 10** Wash plant drainage
- 11** Gas oil tanks
- 12** Workshop
- 13** Rutting hot spot (maintain)
- 14** Dip in ground; liable to flooding
- 15** Rail loading
- 16** Covered store
- 17** Drainage convergence point
- 18** Aggregate tip-off area
- 19** Rinsing screen
- 20** Triple loading point
- 21** Pothole hotspot; maintenance wheel
- 22** Wash
- 23** Road liable to freezing; ensure gritted
- 24** Annual tree survey required

Examples of Best Practice Changing Weather

A site had laid out segregated pedestrian routes to keep pedestrians safe from moving vehicles. During wet weather the pedestrian route became flooded and muddy in parts. This led to pedestrians walking along in non-pedestrian areas.

In order to address this, the business installed better drainage and raised the roadway level.

A site had a long access road through a wooded area. This made it more prone to being blocked by fallen trees in stormy conditions. Tree-safety surveys were conducted on a regular basis to minimise the risk of trees being blown down and either blocking the road or striking a vehicle.



PLAN

Run a risk profile to establish which areas of the business will be most affected by extreme weather conditions.

DO

Keep up-to-date on weather that will affect your sites and drivers. Communicate increased risks to drivers and pedestrians.

CHECK

Review incident reports from previous years in line with weather patterns. Make note of which solutions were most effective.

ACT

Develop your next PLAN assuming the worse-case scenario for each weather type and put practicable solutions in place.

Process Safer by Sharing

Inductions

Inductions are a key step in keeping people safe on sites. This applies equally to new changes to contractors, hauliers and visitors. We must inform people of the operations, risks and controls they will face while on site.

Workers are as likely to have an accident in the first six months at a workplace as during the whole of the rest of their working life (source HSE). Also, contractors used to deal with emergency breakdowns or irregular maintenance need to have segregated areas specific to their need, e.g. tyre fitters.

Length of time in job	Reportable injury	All workplace injury
Less than 6 months	3,316	9,861
6 to 12 months	1,023	3,821
1 to 5 years	1,084	3,092
Over 5 years	973	2,829

The extra risk arises due to:

- Lack of experience of working in a new industry or workplace
- Lack of familiarity with the job and the work environment
- Reluctance to raise concerns (or not knowing how to)
- Eagerness to impress workmates and managers
- Temporary contractors, tyre changing fitters etc. present specific difficulties and risks.

This means workers new to a site:

- May not recognise hazards as a potential source of danger
- May not understand 'obvious' rules for use of equipment that more experienced workers would deem as 'common sense'
- May be unfamiliar with site layout, especially where site hazards may change from day to day
- May ignore warning signs and rules, or cut corners.

Questions every site should ask:

- Who will be inducted?
- How does the induction differ for different groups of people, e.g. contractors, drivers or office staff?
- When will the induction take place?
- What needs to be communicated before the induction, such as PPE and competence?
- Does the induction cover the work the individuals will be doing, or can it be tailored to remove unnecessary information?
- Does the induction cover all the significant risks an individual has the potential to encounter?
- Is the induction trainer competent and confident?
- How will understanding and retention of information be tested?
- How do you keep a record of those that have completed induction?
- When will the induction training be repeated?
- Does the induction include sign off on competence, any required qualification or certifications, or authorisations required before work can commence?
- Does the format of the induction support more interaction, capture a wider audience and cover the points in more detail?
- Does the induction take advantage of visual aids to illustrate key risk areas and focus points, e.g. aerial photos?
- Are available areas segregated to allow tyre fitters and such contractors to undertake their work safely and are they used?



PLAN

Determine the groups and individuals that will require induction. Identify which areas the induction needs to cover to keep all groups appropriately informed.

DO

Deliver an induction that best meets the needs of the PLAN including any visual materials that might be required. Target individuals with the highest risk profile as a priority.

CHECK

Follow up on any implemented inductions through VFL of site visitors. Paperwork isn't enough to confirm success.

ACT

Review your first cycle to develop a more dynamic induction that enables wider groups of people who may encounter changing hazards.



Example of Induction Best Practice Site



Site exclusion zones





Sweeper/Sprayer Exclusion Zone
General

READ TO THE AUDIENCE
OUR AIM IS: To introduce a control measure to reduce the risk to site personnel of contact with Mechanical Road Sweepers whilst they carry out sweeping operations.

READ TO THE AUDIENCE

1. Recently there has been a high potential incident involving contact between a sweeper and a tipper lorry on site. The vehicle accident was itself a serious incident but the severity was increased because the driver of the tipper lorry was cleaning down the rear of his vehicle and standing in close proximity to the point of impact. This incident could very easily have resulted in serious injury or worse.
2. Due to the nature of the sweeper and sprayer operations it is not practical for a banksman to control their reversing manoeuvres continually. For this reason, a different method is required.
3. The control method to be implemented is to create an exclusion zone covering the area that a sweeper or sprayer could potentially be reversing into without the aid of a banksman. As the planning operation moves forward through the site, there will be an area behind that will need to be swept before tack coat can be applied and for new material to be laid onto. This area will become the sweeper/sprayer work zone. This work zone will become a total exclusion zone which will only be occupied by the sweeper/sprayer. No site personnel shall enter this exclusion zone at any time during their operations. The exclusion zone extents will be from the rear of the planning operation to a traffic cone placed 5m past the furthest point the vehicle will need to reverse up to. To ensure maximum visibility an **Eflare** (high intensity flashing beacon), will be placed on top of the cone.
4. Once the operations are complete within the exclusion zone, the sweeper/sprayer driver will remove the beacon and traffic cone signalling to all that the exclusion zone is no longer is live.
5. While the exclusion zone is in place it will also be considered a no stopping zone for vehicles. Any vehicles needing to pass through the live exclusion zone must first make contact with the sweeper/sprayer driver and work must stop until the vehicle has passed through.
6. **Eflares** will be held by the surfacing gangs and it is the responsibility of the site Supervisor/Foreman to ensure this process is in place and available on all sites.
7. The Surfacing Supervisor/Foreman is responsible for allocating a dedicated member of the gang to control the exclusion zone. This appointed person shall stand at the rear of the exclusion zone by the cone and **Eflare** and shall be in contact by with the sweeper driver by means of a **2-way radio system**.
8. Sweeper and Sprayer drivers will be instructed not to start work unless this control measure is in place.
9. The above must be reiterated to all staff during the pre-start Daily Task Briefing.
10. The above control measure will also apply to bitumen sprayers.





TOOLBOX TALKS







Site exclusion zones

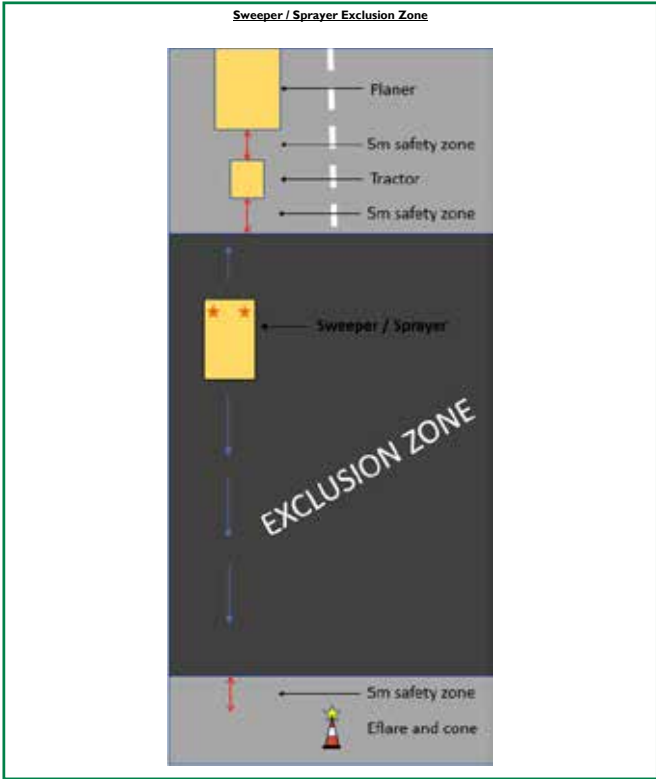

Sweeper/Sprayer Exclusion Zone
General

Sweeper / Sprayer Exclusion Zone





TOOLBOX TALKS



Example of Induction Best Practice Visiting Driver

Site Information
Cardiff Wharf
 Hanson Aggregates, Cardiff wharf, Roath Dock Road
 Cardiff Docks, Cardiff CF10 4ED

Site Contacts: 07976 575 682
 Site Manager - Luke Owen; 02920 451123
 Site Manager - Luke Rosendale/office; 02920 463215
 Frontx office:

Please Ensure:

- You're signed in on site
- Reported to your Hansen point of contact
- Obtained authorisation to continue into the loading area
- Do not exit your vehicle unless on the weighbridge/loading bay
- Always stay on the walkways provided
- Sign-out of site when leaving

Site Hazards:

- HGVs
- Mobile Plant
- Moored ships
- Wet stock piles

This list is not exhaustive so please be aware of the hazards which are around you.

First Aid

The site first aiders are Luke Owen & Luke Rosendale
 First aid kits are available at the site office/warehouse, both the first aid room and kits can be seen on the site layout.

PPE

The following items are mandatory on our site:

- Subsidiary safety head protection
- Safety footwear (back up boots)
- High visibility clothing (waist coat and over trousers as a minimum)
- Safety eye protection (goggles or glasses)
- Protective gloves
- Other necessary PPE will be indicated by signage
- Contractors must provide their own PPE as described above and ensure it is fit for purpose.

Emergency Procedure

In the event of an emergency, firstly ensure any alarm or warning system is raised to warn others. Secondly ensure that the Hansen Contact is made aware of the incident. The responsible manager for site will manage.

First aid provisions, notifying and dealing with emergency services and Evacuation of site personnel.

If equipped the assembly points are located on the site map, but are located at the car park and outside the main entrance. All personnel must proceed to the assembly point immediately without stopping to collect belongings. Personnel must not return to the place of work until the all clear has been given by the incident controller.

Accident, Incident and Near Hit Reporting

Reportable incidents:
 It is extremely important that you report incidents to your Hansen point of contact within 30 minutes. The following incidents MUST be reported BEFORE leaving site:
 ALL accidents which result in personal injury or damage to property
 Any chemical spill, potential groundwater or surface water contamination.

Near Hits:
 Please report any incident that did not result in damage or injury, but could have if the circumstances were different.
 If an incident occurs that has the potential to cause LOST TIME, IT MUST be escalated to the site manager immediately.

If at any point you are unsure, STOP and ask for advice from your Hansen point of contact.

Cardiff Wharf
 Hanson Aggregates, Cardiff wharf, Roath Dock Road
 Cardiff Docks, Cardiff CF10 4ED

Key

- First aid room
- Spill kit location
- Gas off tank
- Site entrance
- Pedestrian walkway
- One way traffic route
- Two way traffic route
- Mobile plant
- Offices
- Site weighbridge
- No entry
- Please stay in designated pedestrian and traffic routes, be aware of other traffic.

If at any point you are unsure, STOP and ask for advice from your Hansen point of contact.

Welcome

- Designated parking areas / reverse parking / handbrake applied / vehicles secured with keys removed from ignition
- Sign in / out
- Welfare facilities
- Key site contacts

Site Overview

- Traffic / pedestrian routes, vehicle movements and restricted areas
- Prohibition on the use of mobile phones other than in office and welfare areas
- Personal Protective Equipment (PPE) requirements, including noise and dust zones
- Smoking / Vaping Policy

Incidents: Near Misses / Hazards, Injuries & Emergencies

- Incidents and Near Miss / Hazard Alert reporting
- Emergency Procedures and Assembly Points
- First Aiders and first aid equipment
- Medication / health conditions

Safety Essentials

STOP & THINK

- Look after yourself and others
- Get a grip
- Manual Handling
- Driving
- Isolation Procedures
- Confined Spaces
- Housekeeping
- Personal Protective Equipment
- Tools and Equipment
- Safe Systems
- Working At Height
- Incident/Hazard Alerts

PPE Requirements

- Hearing protection (as required)
- Safety helmet
- Eye protection
- Hi-viz jacket
- Protective gloves
- Hi-viz trousers
- Lace up safety boots (no flippers)

Operational areas and site signage must be complied with:

- Maintain 3 metres / starways for vehicles
- Mobile plant / vehicles: Do not drive vehicles into operational areas without permission from site management and vehicles must give way to site vehicles unless otherwise instructed.
- Cameras (including mobile phones) and two way radios must not be used on site without authorisation
- Seat belts must be worn
- Observe traffic routes and comply with speed limits (10, 15, 20)
- Observe exclusion zones around vehicles and mobile plant, especially tipper
- Never enter mobile plant working areas without authorisation and unless the driver has acknowledged you and parked up safely.

Environmental

We are committed to caring for communities - respecting the natural environment and our neighbours by:

- Minimising emissions to air, land and water including preventing dust and spills
- Minimising noise, vibration and waste
- Protecting habitats and wildlife
- Reporting all environmental hazards, incidents and complaints
- Please let us know if you see any areas for improvement

COMMUNITIES

Example of Induction Best Practice

Visitor including office staff

SITE LAYOUT



A comprehensive site induction board. On the left, it lists safety rules: '8 MAXIMUM SPEED ON THIS SITE AT ALL TIMES', 'MOBILE PHONES ARE NOT PERMITTED WHILST DRIVING', 'ALL VISITORS MUST SIGN IN AT RECEPTION', 'STOP! WAIT FOR SHOVEL DRIVER BEFORE ENTERING', 'BRETT CONCRETE PLANT', 'SHEDDING AREA', 'RECEPTION / WEIGHBRIDGE', 'MAIN CAR PARK', 'NO ENTRY TO VEHICLES', 'RESTRICTED AREA', 'ONE WAY SYSTEM', 'PEDESTRIAN FOOTPATH ROUTE', and 'VEHICLE ROUTE TO SKY AGGREGATES'. On the right, it features a 'MANDATORY PPE' list, a 'Caution' sign for 'LARGE VEHICLES OPERATING', and a detailed site map with various zones and facilities like 'SUPERVISOR'S OFFICE', 'TOILETS', and 'FIRE ASSEMBLY POINT'. The bottom right corner includes the 'LYDD QUARRY' logo and 'Brett' branding.

A site induction board focusing on material stockpiles. At the top, a red banner reads 'STOP! WAIT HERE TO BE CALLED FORWARD REMAIN IN YOUR VEHICLE AT ALL TIMES'. The board features a central aerial map with labels for material types: 'OVERSIZE 10 / 20MM', '6MM GRIT', 'SHARP SAND', 'CONCRETE SAND', 'WEIGHBRIDGE', 'NATURAL SAND', 'FINE SAND', '10MM BALLAST', '10MM GRAVEL', 'GRADED GRAVEL', '20MM GRAVEL', and '40MM GRAVEL'. A red line on the map indicates 'YOU ARE HERE' near the 'WEIGHBRIDGE'. Safety rules at the bottom include 'NO OVERTAKING ON THIS SITE AT ANY TIME', '8 MAXIMUM SPEED ON THIS SITE AT ALL TIMES', and 'MOBILE PHONES ARE NOT PERMITTED WHILST DRIVING'. A sign on the right states 'Personal protective equipment must be worn'. The bottom right corner includes the 'Brett' logo.

Collect Customer Rules when visiting Site











Site safety rules and induction card

This card is provided to assist you to better understand the dangers of not adhering to the site safety rules. You must comply with these rules.



The rules will be strictly enforced to ensure that our sites are places where people can work and visit without being hurt. We want to keep everyone safe.

When you first arrive on site you will be given an induction about the site rules and asked to sign and retain this card to show that you have received an induction.

DO

 Obey site PPE rules	 Obey site traffic routes	 Stay in vehicle wherever possible - always wear seatbelt	 Use 3 points of contact getting in and out of vehicles
 Obey site speed limits	 Stay within pedestrian zones and walkways	 Stay in vehicle at all times when being loaded	 All vehicles must be sheeted before leaving site
 Obey site tipping procedures		 You must sheet in the designated area	

DO NOT

 Ride on the back of moving vehicles	 Use mobile phones whilst driving	 Drop litter or leave rubbish on site
 Come on to site under the influence of drugs or alcohol	 Do not allow gas cylinders to come into contact with hot materials.	 Bring children or pets on to site
 Use diesel as release agent		

I confirm that I have read, understood and accept the site rules with which I must comply. I understand that failure to adhere to these rules may result in my exclusion from the premises.

Signed..... Date

Print Name

Company Name

For and on behalf of

Vehicle Management

Every year, there are over 5,000 accidents involving transport in the workplace. About 50 of these result in people being killed (www.hse.gov.uk/statistics).

The main causes of injury are people falling off vehicles or being struck or crushed by them in the workplace.

Employers have a duty to ensure that the health and safety of their employees, contractors and members of the public are not put at risk because of the work they do. Employees and the self-employed also have a duty to look after their own health and safety and that of anyone who might be affected by their workplace.

Every site is different and likely to present different hazards and risks; however a well-designed and maintained site with suitable segregation of vehicles and people will make workplace transport accidents less likely.

workplace transport Checklist:
www.hse.gov.uk/workplacetransport/wtchk1.pdf

Best Practice Vehicle Management

Questions every site should ask:

- Does the site have entrance signage that gives clear, necessary information as an individual first enters the site?
- Do all the vehicles entering site have a form of accreditation and have correct safety equipment?
- Does the site have a clear route of access and egress?
- Does the site have clear route signage?
- Does the site have clearly sign posted speed limits?
- Is the on-site signage consistent with the Highways signage and easily recognisable?
- Does the site have clear designated parking areas?
- Does the site have a reverse parking policy?
- Does the site have complete segregation between vehicles and pedestrians?
- Does the site have pedestrian-free zones?
- How do you manage the crossing points between vehicles and pedestrians?
- Are all pedestrian walkways well maintained and well lit?
- Does the site have a one-way system?
- Does the site have a process in place for adverse weather conditions designed to protect both vehicles and pedestrians?
- Does the site have a process in place for combatting uneven surfaces or potholes?

Best Practice Entrance Signage

Entrance signage is the first point of communication an individual has with the rules of the site. These are often seen very briefly and so need to convey the most important, immediate information required before individuals are parked and inducted on site.

Good entrance signage should include:

- Clear directions, perhaps in the form of a site plan
- Site rules which are applicable before they reach reception
- Emergency contact details.

Too much information can confuse or frustrate individuals, and will be more likely to lead to the instructions being obeyed incorrectly. Sometimes, a series of signs are required which guide an individual around the site. Again, too many of these signs could be misinterpreted, so essential information is key to maximising a signs effect.



Best Practice Signage

Every site will also have a SITE SAFETY RULES sign informing visitors of the PPE requirements. Signs should be:

- Placed where they can be seen.
- Conforming to Highway Code standards if relevant to site traffic
- Clear and easy to understand.
- Positioned so people have time to understand them and then take action before they reach the hazard.
- Kept clean and well-maintained so they are visible at all times.
- Reflective or phosphorescent if they have to be visible in darkness and, where possible, adequately illuminated.



Best Practice Vehicle Exclusion Zones

Tragically, a contractor artic tipper driver delivering on behalf of a MPA member sustained fatal injuries when the cab of his vehicle was crushed by a tipper that overturned.

When making deliveries, all drivers should be managing the space around them and maintaining an exclusion zone to avoid anyone entering this area.

If you are delivering and have any safety concerns, please advise the site staff as well as your MPA member contact, and complete a Near Miss/Hit/Hazard Observation Form.

- ✓ **DO** - Keep vehicles and people apart
- ✓ **DO** - Ensure people are kept a safe distance from discharging vehicles
- ✓ **DO** - Apply **MYSACE** principles

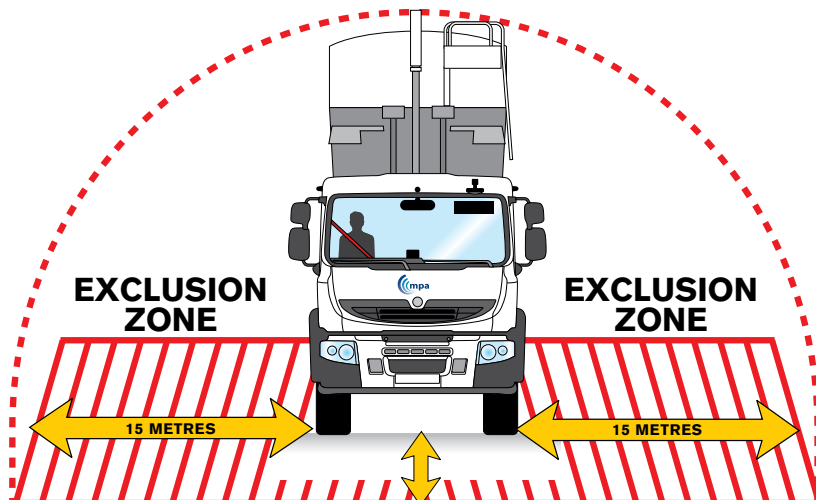

Best Practice Pedestrian Routes

- Where possible every site will have dedicated pedestrian routes
- As a general rule, if the pedestrian route is alongside a roadway and there is no kerb, the pedestrians must be segregated by a robust physical barrier made of material designed to prevent the pedestrian being injured, such as steel or concrete which is at least 0.8m high
- If the pedestrian route is within a traffic route and there is a kerb, then robust steel fencing or a handrail will be adequate
- Bunds may be used as a physical means of segregation; however they must be suitable for the largest vehicle accessing the traffic route
- If the pedestrian route is away from a traffic route, then alternative suitable fencing can be used.

Typical pedestrian route segregation



No kerb



Kerb



All pedestrian crossing points within a traffic route must have:

- Specific yellow goalposts highlighting the pedestrian crossing
- A self-closing yellow gate, with any relevant signage sign facing the pedestrian on approach
- The gate must open towards the pedestrian, not into the traffic flow. Providing the goalposts clearly indicate the route, it is not always necessary to apply road markings.



Best Practice Traffic Direction

- Clear directional signage should be used to lead people along their route whether they are controlling a vehicle or travelling as a pedestrian
- Traffic routes should be wide enough for the safe movement of the largest vehicle that is likely to be on site
- Surfaces must be suitable for the vehicles and pedestrians using them.
- Every workplace should have suitable and enough lighting, particularly in areas where pedestrians and vehicles interact, and loading / unloading takes place
- Haul roads should be designed, constructed and maintained to allow vehicles and plant to be used and moved upon them safely
- One-way systems are often more efficient, as they prevent the need for reversing manoeuvres, which are higher risk.

Best Practice Speed Limits

- Speed limits need to be clearly signposted, in the same style as highway signage in order to prevent confusion
- Speed limits may need to be reduced based on the size of the vehicles travelling, the layout of the site, and the presence of pedestrians
- Regular checking and enforcing of speed limits will help to deter speeding on site
- Fixed traffic-control measures such as speed humps, chicanes and 'rumble strips' can help to ensure speed limits are enforced
- It is important to select the most appropriate control, as the wrong measure can increase risk by, for example, reducing vehicle stability.



Best Practice Parking

As far as possible, keep parked vehicles out of the flow of traffic and people. If possible, drivers leaving parked vehicles should not have to cross potentially dangerous work areas or traffic routes. Physical precautions such as bollards and barriers can help to prevent vehicles from crossing into walking areas and improve safety for pedestrians.

Inform drivers where parking areas are as soon as they enter the site. Try to lay out parking areas to reduce manoeuvring and reversing for large vehicles.

Where possible, you should provide parking areas for all vehicles using the workplace, including work-related vehicles, private cars, motorcycles and pedal cycles. Parking areas should be in safe and suitable places.

Parking areas:

- Must be clearly signposted
- Must have suitable ground conditions
- Should have a minimal gradient
- Must have suitable drainage
- Provision for adverse weather conditions
- Must be well lit (if possible)
- Must be as close as possible to where people need to go when they leave their vehicles (for example, refreshment facilities for visiting drivers)
- Should be in safe and suitable places providing enough access for pre use checks if required.



Best Practice Reverse Parking Policy

Roughly one in seven vehicle incidents occur in parking areas, and they are an important environment to set the tone for safety throughout the working day.

www.slate.com/articles/life/transport/2011/02/youre_parking_wrong.html

Note: On-site heavy mobile plant operates a “first move forward policy”, as reversing such plant is highly dangerous.

Reverse parking policies reduce incidents by:

- Confining the reversing manoeuvre to a parking space as opposed to the parking area
- Giving the driver greater field of vision as they leave the parking space
- Make safety a first thought when anybody arrives on site.

Best Practice Edge Protection

- Every site will have suitable roadside edge protection as necessary, to warn the driver the edge is there and to stop the largest fully loaded vehicle crossing it when travelling at the maximum foreseeable speed.
- Vehicles must be prevented from going over the edges of haul roads, quarry faces, slopes or into lagoons / reservoirs by the provision of adequate edge protection. The height of the edge protection must be at least 1.5m, with a target of 1.75m where possible and always greater than half the wheel height of the largest vehicle using the adjacent roadway.
- Where vehicles reverse up to structures or edges, barriers, buffers, bollards and wheel stops can be used to warn drivers where they need to stop. Make sure they are highly visible, sensibly positioned and capable of stopping a vehicle at low speed.



Best Practice Slopes and Gradients

Slopes and Gradients need to be considered as additional hazards for both Vehicles and Pedestrians.

For Vehicles, consider enforcing a reduced speed limit. Drivers should not be allowed to exit their vehicles or cabs on these surfaces as they can increase the risk of slip, trip and fall injuries. Loading and discharging should also be prohibited in these areas, or additional safety measures put in place if loading and discharging must take place.

Where vehicles have to be parked on a slope, they should:

- Be parked facing up or down the slope, never side on
- Have their brakes applied
- Be left in gear (when it is safe to do so)
- Wheel-chocks must be used when necessary
- Drivers must NEVER leave their vehicles without making sure that the vehicle and its trailer are securely braked
- Remove the keys if leaving the vehicle for along period
- if a vehicle moves unintentionally do not attempt to re-enter the cab.

For pedestrians, consider placing chevrons on the floor to alert individuals to the increased risk. These areas in particular need to be kept well-lit and well-maintained during winter. Ultimately, as with vehicles, if there is an alternative route that doesn't traverse slopes or gradients, these should be prioritised and the walkways kept contained.

Best Practice Loading and Discharge

- Loading, discharging and feeding areas shall be physically segregated to separate mobile equipment from traffic routes
- When this cannot be achieved it will have to be managed locally and included within the on-site risk assessment
- The loading and unloading area should be:
 - clear of traffic with no people involved in the activity
 - on level ground
 - segregated from other work areas
 - clear of overhead cables, pipes or other obstructions
 - protected from bad weather where possible
- Vehicles less than 7.5 tonnes must be placed in a suitable place of safety away from traffic / mobile plant movements
- one vehicle only tipping at a time.



Best Practice Loading and Discharge

- The need to access the back of trucks should be eliminated where possible, with loads being secured / released from ground level
- Drivers must remain in the cab of their vehicle, or in a specific safe place of refuge, when loading / unloading
- If drivers need to access the back of their vehicles, a suitable means of access and egress will be required e.g. platforms or gantries so as to minimise the risk of falls from height
- Edge protection on vehicles should be suitable and sufficient. Where vehicles don't have edge protection, PPE must be used to protect the individual, e.g. personal fall protection that is connected onto a suitable anchor point
- Specific arrangements should be implemented to ensure the risk of falls from height to collect customers is minimised.



Example of Best Practice Site Plan

FAILURE TO WEAR THE CORRECT PPE WILL RESULT IN DENIED ACCESS OR EXCLUSION FROM SITE

Ribblesdale Works
Hanson Cement, West Bradford Road, Clitheroe, Lancashire BB7 4QF

Hanson
HEIDELBERG CEMENT Group

Key

- First aid room
- Spill kit location
- Gas oil tank
- Site entry/exit
- Pedestrian walkways
- One way traffic route
- Two way traffic route
- Muster point
- Lifeguard
- Fire extinguisher
- No entry
- Please stay on designated pedestrian and traffic routes, be aware of other traffic.

Legend

- First Aid
- Fire Assembly Point
- Car Protection Required
- Pedestrians and vehicles must follow designated routes
- Smoking is not permitted in buildings/enclosed or near any flammable material

If at any point you are unsure **STOP** and ask for advice from your Hanson point of contact.
STAY SAFE at Hanson & thank you for your cooperation

Document Number UKCP01.G9c Version 2 (Ribble)

CONWAY
great people - great work

PEDESTRIAN SAFETY GATE: KEEP CLOSED

PEDESTRIANS MUST FOLLOW YELLOW WALKWAYS AT ALL TIMES

MULBERRY WAY

Drain

Example of Best Practice Site Plan

Vision 2020 Site evolution

2016. Project definition for 2020 expectations



- ☐ People access control
- ☐ Vehicles access control
- ☐ Pedestrian routes
- ☐ Traffic routes
- ☐ Loading areas
- ☐ Central control room
- ☐ Dust reduction

Material solutions *advancing life*



Lifesaving rules. Traffic plan

Access control for people and vehicles







Material solutions *advancing life*

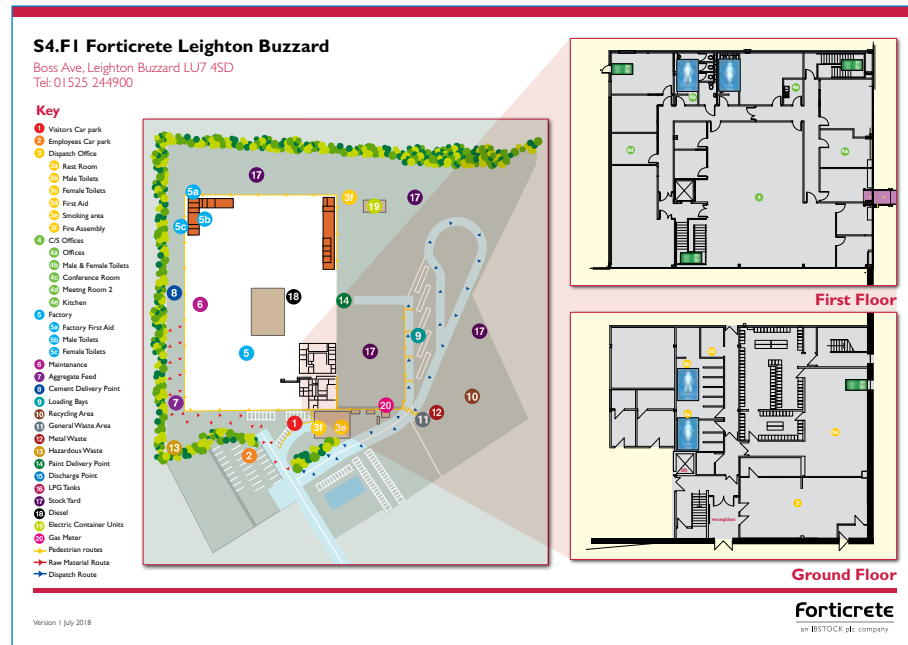

Example of Best Practice Site Plan



Best Practice Managing Special Hazards

The variety of sites across MPA members will by their very nature throw up many different special hazards. The rural position of quarries, docks, rail sidings etc. will all have their own challenges. These might include trespassers, people grazing horses, members of rural communities expressing a historical use of the land and wishing to continue, etc.

Here, a few examples will be given on how some of these challenges have been met, but every business must review its own sites and operations and consider what special challenges are likely to be met.



Examples of Best Practice Managing Special Hazards

Questions every site should ask:

- Are there any public rights of way that run through the site?
- Have you made arrangements on site for safe passage of pedestrians to pass through on the right of way?
- Is there shared access with members of public to amenities?
- Are there any features on the site that might attract trespassers, e.g. historical monuments or old quarry lagoons/flooded quarries
- Are there local residents associations, community groups or access forums you can engage with?
- On sites on industrial estates, do roads have markings in line with the Highway Code?
- Do you have any history of protest, or are working on projects that might attract protest?
- Is there a previous history of trespass or incidents?
- Do you have a system to capture such incidents?
- Do you review incidents and trends in incident records and take appropriate action to minimise the risk?
- Does the standard of your fencing and barriers match the risk?
- Have you included all of the above in your risk assessments, site plan and induction for site
- Are there any edges on site that need additional protection or allowances?
- Are there any uneven surfaces or slopes on site that need additional protection or allowances?

A member's site includes a historic military fort that attracts a great deal of interest, both from locals and military historians. The fort is located on the end of the site with access via a public footpath. The site has used palisade fencing to keep trespassers out and signs to warn of the dangers within the fenced-off area. Fencing is inspected every week and during peak times security guards are employed to deter trespassers. YouTube is scanned regularly to look for new videos posted showing how and when access has been gained.

The public footpath continues under the field conveyor system, where members of the public are shepherded under an elevated section of conveyor by fencing. The underside of the conveyor has additional guarding. Part of the Mobile Plant Operators' induction and training on-site is to warn of the likely presence of members of the public in this area and to make sure plant movements are kept to a minimum.

The MPA Stay Safe campaign is a very useful tool to help spread the message about site safety and risks to trespassers among young persons via local schools. Each year the MPA will contact schools close to sites and offer resources to warn of the dangers from trespassing onto sites. Has the business engaged with MPA to be part of this campaign and has the site helped to promote Stay Safe through staff and social media outlets?



PLAN	DO	CHECK	ACT
Speak with site staff as well as other interested parties to gain a holistic understanding of the risk.	Communicate to all parties involved the systems and processes in place designed to keep people safe.	Use additional tools such as CCTV, social media, YouTube and local forums to gauge awareness levels.	Create an annual committee in which all interested parties can review the success of the initial PLAN and continue to improve community safety.



Performance Safer by Association



Auditing

Safety audits are an essential part of a successful business. Effective health and safety auditing not only provides the legal framework for compliance, it also lays the foundations for continuous safety improvement to enhance competitive advantage. The main duty of any health and safety auditor is to look at your organisation’s safety management systems and assess them in line with the chosen criteria. While an audit is used to assess health and safety management systems, it is important to view an audit as a positive; it’s a chance to highlight company successes and an opportunity to praise staff for their excellent work

There is no right or wrong time to conduct an audit. They can be useful tools, whether you are starting out in the PLAN stage of the PDCA cycle, or if you are reviewing your performance and looking to ACT upon the results.

7 Checklist for dutyholders



Site inspection - workplace transport checklist

- The following checklist has been prepared as a guide to what employers should consider when trying to reduce the risk from vehicles in the workplace. It will not necessarily be comprehensive for all work situations
- If the answer to a question is 'No', the references under the section heading indicate where further advice can be found.
- If the question is not relevant to your workplace leave the boxes blank.

1 MANAGEMENT AND SUPERVISION OF WORKPLACE TRANSPORT RISK.

See references 1, 2, 3, 4, 5

Check, in consultation with your employees, that your level of management control/supervision is adequate

Are site rules documented and distributed?	Yes <input type="checkbox"/>	No <input type="checkbox"/>
Are your supervisors, drivers and others, including contractors and visiting drivers, aware of the site rules? Are they aware of their responsibilities in terms of helping to maintain a safe workplace and environment?	Yes <input type="checkbox"/>	No <input type="checkbox"/>
Has a risk assessment been completed for all workplace transport hazards?	Yes <input type="checkbox"/>	No <input type="checkbox"/>
Is the level of supervision sufficient to ensure that safe standards are maintained?	Yes <input type="checkbox"/>	No <input type="checkbox"/>
Are sanctions applied when employees, contractors, etc., fail to maintain these standards?	Yes <input type="checkbox"/>	No <input type="checkbox"/>
Are adequate steps taken to detect unsafe behaviour of drivers of both site and visiting vehicles as well as pedestrians? Are the underlying reasons investigated to correct unsafe behaviours?	Yes <input type="checkbox"/>	No <input type="checkbox"/>
Is there good co-operation and liaison on health and safety matters between your staff and those who collect or deliver goods?	Yes <input type="checkbox"/>	No <input type="checkbox"/>

Check what your drivers and other employees actually do when undertaking their work activities

Do drivers drive with care, e.g., use the correct routes, drive within the speed limit and follow any other site rules?	Yes <input type="checkbox"/>	No <input type="checkbox"/>
Do your drivers and other employees have enough time to complete their work without rushing or working excessive hours? Do you monitor "job and finish" work to ensure drivers are not rushing to cut corners?	Yes <input type="checkbox"/>	No <input type="checkbox"/>
Are your employees using safe work practices, e.g., when (un)coupling, (un)loading, securing loads, carrying out maintenance etc.?	Yes <input type="checkbox"/>	No <input type="checkbox"/>
Do managers and supervisors routinely challenge and investigate unsafe behaviours they may come across?	Yes <input type="checkbox"/>	No <input type="checkbox"/>
Do managers and supervisors set a good example, for instance by obeying vehicle/pedestrian segregation instructions, and by wearing high visibility garments where these are needed?	Yes <input type="checkbox"/>	No <input type="checkbox"/>

2 SITE LAYOUT AND INTERNAL TRAFFIC ROUTES.
See references 1, 2, 6, 7, 8, 9, 10

Check that the layout of routes is appropriate

- Are the roads and footways suitable for the types and volumes of vehicular traffic and pedestrian traffic using them? Yes No
- Are vehicles and pedestrians kept safely apart? Yes No
- Where necessary are there suitable pedestrian crossing places on vehicle routes? Yes No
- Is there a safe pedestrian route that allows visiting drivers to report for instructions when entering the site? Yes No
- Are there adequate numbers of suitable parking places for all vehicles and are they used? Yes No
- Is there a properly designed and signed one-way system used on vehicle routes within the workplace? Yes No
- Is the level of lighting in each area sufficient for the pedestrian and vehicle activity? Yes No

Check that vehicle traffic routes are suitable for the type and quantity of vehicles, which use them.

- Are they wide enough? Yes No
- Do they have firm and even surfaces? Yes No
- Are they free from obstructions and other hazards? Yes No
- Are they well maintained? Yes No
- Do vehicle routes avoid sharp or blind bends? Yes No

Check that suitable safety features are provided where appropriate.

- Are roadways marked where necessary, e.g. to indicate the right of way at road junctions? Yes No
- Are road signs, as used in the Highway code, installed where necessary? Yes No
- Are features such as fixed mirrors (to provide greater vision at blind bends), road humps (to reduce vehicle speeds), or barriers (to keep vehicles and pedestrians apart) provided where necessary? Yes No

3 VEHICLE SELECTION & SUITABILITY

See references 1 & 2.

Check that vehicles are safe and suitable for the work for which they are being used.

- Have suitable vehicles and attachments been selected for the tasks which are actually undertaken? Yes No
- Do vehicles have good direct visibility or devices for improving vision where reversing can't be eliminated and where significant risk still remains eg external and side mirrors; vision aids such as CCTV; sensing device? Yes No
- Are they provided with horns, lights, reflectors, reversing lights and other safety features as necessary? Yes No
- Do they have effective service and parking brakes? Yes No
- Do they have seats and seatbelts where necessary? Yes No
- Are there guards to prevent access to dangerous parts of the vehicles, eg power take-offs, chain drives, exposed exhaust pipes? Yes No
- Do drivers have protection against bad weather conditions, or against an unpleasant working environment, ie the cold, dirt, dust, fumes and excessive noise and vibration? Yes No
- Is there a safe means of access to and exit from, the cabs and other parts that need to be reached? Yes No
- Are surfaces, where people walk on vehicles, slip resistant? Yes No
- Is driver protection against injury in the event of an overturn, and measures in place to prevent the driver being hit by falling objects, provided where necessary? Yes No
- Are operators involved or consulted on vehicle selection? Yes No

4 VEHICLE MAINTENANCE

See references 1 & 2.

Check the level of vehicle maintenance is adequate.

- Is there a regular preventative maintenance programme for every vehicle, carried out at predetermined intervals of time or mileage? eg in accordance with manufacturers instructions Yes No
- Is there a system for reporting faults on the vehicle and associated equipment and carrying out remedial work? Yes No
- Where vehicle attachments lift people or objects, are thorough examinations undertaken by a competent person (e.g. your insurance company)? Yes No
- Do the drivers carry out basic safety checks before using the vehicle? Yes No

5 VEHICLE MOVEMENTS

See references 1 & 2.

Check that the need for REVERSING is kept to a minimum, and where reversing is necessary that it is undertaken safely and in safe areas.

- Have drive-through, one-way systems been used, wherever possible to reduce the need for reversing? Yes No
- Where reversing areas are needed are they marked to be clear to both drivers and pedestrians? Yes No
- Are non-essential personnel excluded from areas where reversing occurs? Yes No
- If risk assessment shows site controls cannot be improved further and you need a banksman to direct reversing vehicles, are they adequately trained and visible? Yes No

6 UN(LOADING) ACTIVITIES

See references 1, 2, 4, 11, 12.

Check that there are safe systems for LOADING and UNLOADING operations.

- Are loading/unloading operations carried out in an area away from passing traffic, pedestrians and others not involved in the loading/unloading operation? Yes No
- Are the load(s), the delivery vehicle(s) and the handling vehicle(s) compatible with each other? Yes No
- Are loading/unloading activities carried out on ground that is flat, firm and free from potholes? Yes No
- Are parking brakes always used on trailers and tractive units to prevent unwanted movement, eg when coupling vehicles? Yes No
- Are the vehicles braked and/or stabilised, as appropriate, to prevent unsafe movements during loading and unloading operations? Yes No
- Are systems in place to prevent trucks driving away while they are still being (un)loaded? Yes No
- Are lorry drivers and others kept in a safe place away from the vehicle while (un)loading is carried out? Yes No
- Is there a safe area marked where drivers can observe loading (if necessary)? Yes No
- Has the need for people to go on to the load area of the vehicle been eliminated where possible and if not is safe access provided and used? Yes No
- Is appropriate lifting equipment available for (un)loading vehicles? Yes No
- Is loading/unloading carried out so that, as far as possible, the load is spread evenly to avoid the vehicle or trailer becoming unstable? Yes No
- Are checks made to ensure the load is adequately secured in line with the Department for Transport Code of Practice and not loaded beyond their capacity before the vehicle leaves the site? Yes No

7 DRIVER COMPETENCE.

See references 1, 2, 13.

Check that your selection and training procedures ensure that your drivers and other employees are capable of performing their work activities safely and responsibly.

- Do drivers possess the necessary licences or certificates for the vehicles they are authorised to drive e.g. FLT's, shunt vehicles, site dumpers etc.? Yes No
- Do you check the previous experience of your drivers and assess them to ensure they are competent? Yes No
- Do you provide site specific training on how to perform the job, and information about particular hazards, speed limits, the appropriate parking and loading areas, etc.? Yes No
- Do you have a planned programme of refresher training for drivers and others to ensure their continued competence? Yes No

Incident/Near Miss Investigation

Accident investigation and Near Miss/Hit reporting monitors the effectiveness of the PDCA PLAN the business has put into place to control the risks. As part of the CHECK section of the PDCA cycle, all incidents should be investigated to best inform the corrective action. Once this action is decided upon it is essential that it is implemented, learning is shared and any necessary improvements are put in place.

Investigations will help a business to:

- Identify why any existing control measures failed and what improvements or additional measures are needed
- Assist in preventing the incident from happening again
- Point to areas where the risk assessment needs reviewing
- Improve risk control in the workplace in the future.

An incident need not occur for an investigation to take place, as valuable information can be retrieved through Near Misses/Hits and hazard observations of unsafe acts and unsafe behaviours. Looking into these instead of waiting for an accident to occur can be invaluable in preventing the accident from ever happening.

Incident – this is an event that causes an injury to a person of any degree of seriousness, or damage to property and equipment, e.g. a forklift truck swerves to avoid a pedestrian, knocking some racking that collapses. Other people working in the warehouse become trapped and injured as a result.

Near Miss – this is an event that occurs without injury or damage to property e.g. an un-chocked vehicle rolls across a yard, coming to a stop without impacting anything.

Unsafe Act – in which the behaviour of a group or individuals increases the risk of an incident occurring e.g. site operatives standing within a vehicle exclusion zone.

Unsafe Condition – in which the working conditions - such as environment or equipment - increased the risk of an accident occurring e.g. poorly maintained walkways with insufficient lighting and uneven ground.

Case Study



This vehicle was involved in a fatal accident due to poor maintenance of the brake system; note the brake fluid over the disc.

Leading / Lagging Indicators

Indicators are any metrics that a business produces that can be used to inform a PLAN in the PDCA cycle. Indicators are commonly separated into two types, Leading and Lagging, although the goal of measuring both is to assess safety performance and determine what needs to be done to improve the safety culture of an organisation.

Lagging indicators are reactive in nature. They measure the effectiveness of a safety program after a PLAN has been implemented.

Typical lagging indicators include:

- Number of Fatalities
- Number of Lost Time Incidents
- First Aid or Minor Injuries that didn't result in Lost Time
- Damage to Equipment/Property
- Equipment Failure or Breakdown
- Near Misses/Hits
- Unsafe Acts or Unsafe Conditions reported.

In contrast, leading indicators are proactive in nature. They consist of safety initiatives or reported activities, with the aim of preventing adverse events before they happen.

Typical leading indicators include:

- Safety Conversations completed
- Health and Safety Training delivered
- Inspections and/or Audits completed
- Employee Involvement through Health and Safety Committees
- Hazard Observation

Leading indicators are widely considered to be more valuable than lagging indicators when it comes to improving workplace safety. However, all indicators need to be used in conjunction with one another to most effectively improve overall safety.

Examples Lagging, Current & Leading Safety Indicators

Lagging (focused on outcomes)	Current (present snapshot)	All workplace injury
<ul style="list-style-type: none"> • Experience Modification Rate (EMR) • OSHA Iota I Recordable Incident Rate (TRI R) • Days Away from Work • Restricted or Transferred Rate (DART) • Total Lost Workdays (TLWD) • Average Cost of Injury • Total Vehicle Crash Rate • DOT-Recordable Accident Rate • Average Cost of Vehicle Crash • Roadside Inspection Violation Rate • On-Road Breakdown Rate & Average Cost of Vehicle Breakdown • Vehicle & Driver Out-of-Service (OOS) Rates • Traffic Enforcement/Moving Violation Rate 	<ul style="list-style-type: none"> • Daily Pre- & Post-Vehicle Inspection Defects Discovered • Daily Record/Reported of Incidents & Vehicle Crashes • Unsafe/Hazard Conditions Action/Corrected Reports • Safety Committee Activities Record • Unsafe Act/Vehicle Crash Follow-Up, Re-Training or Corrective Action Events • Number of Daily Job-Safety Observations Conducted • Report of Failed Roadside Inspections (Inspection w/violations) 	<ul style="list-style-type: none"> • Safety Training Infrastructure Activities: <ul style="list-style-type: none"> - Schedule of New Employee/Driver Safety Orientation - Percent of Monthly/Quarterly Safety Training Completed - Percent of Employee/Driver Participation in Safety Training (a measure of engagement) - Number of Pre-Shift Safety Briefs Conducted - Percent of Incident/Crash Follow-Ups Completed - Percent of Root Cause Analysis Conducted on Actual and Near-Miss Incidents and Crashes • Annual Risk/Safety Assessment Conducted • On-Road Driver Behavior Monitoring in Real Time (speeding & hard braking events) • Lane Departure Warning Alerts • At-Risk/High-Risk Employees/Driver Proactively Identified • Annual & QoQ Vehicle Crash Analysis Conducted • Annual & QoQ Incident Analysis Conducted

The following is a short list of priority leading indicators to track:

Safety Training - Evaluating a fleet organisation's current state of safety culture - and level of safety program maturity - always starts with a critical look at its safety training infrastructure. Training drivers on safe on-road behaviours and thorough vehicle inspection procedures is considered a good leading indicator because it correlates to a fleet's overall safety performance.

Reference

Construction Skills Certificate Scheme

Highways England Passport Scheme

Construction Industry Training Board CITB

Avette Contractor Prequalification and Compliance Management

Mineral Sector Safety Passport

CITB Construction Plant Competence Scheme

Partner Operated Scheme

MP Skills Drivers Skill Card

MPQC Mineral Products Qualifications Council (MQPC) Standards

Certificate of Professional Competence

Vulnerable Road User

Safe Urban Driving

National Examination Board in Occupational Safety and Health (NEBOSH)

HSE Recognised Sector Specific Vocational Qualifications

MPQC Plant Operator Competency Scheme

Website Links

Mineral Products Association
www.mineralproducts.org

MPQC
www.mp-qc.org/

Mineral Products Association Safequarry
www.safequarry.com

Road Haulage Association
www.hse.gov.uk/statistics

Freight Transport Association
www.hse.gov.uk/workplacetransport/wtchk1.pdf

Institute of Road Transport Engineers
www.slate.com/articles/life/transport/2011/02/youre_parking_wrong.html

CTrack Telematics
www.ctrack.co.uk

Spillard
www.spillard.com

Vision Techniques
www.vision-techniques.com/brakesafe/about-brakesafe

Please ensure that you report all accidents or incidents.

If you see anything on your sites or customer sites that you think is unsafe, it is okay to Stop and Report it to us as a Near Miss.

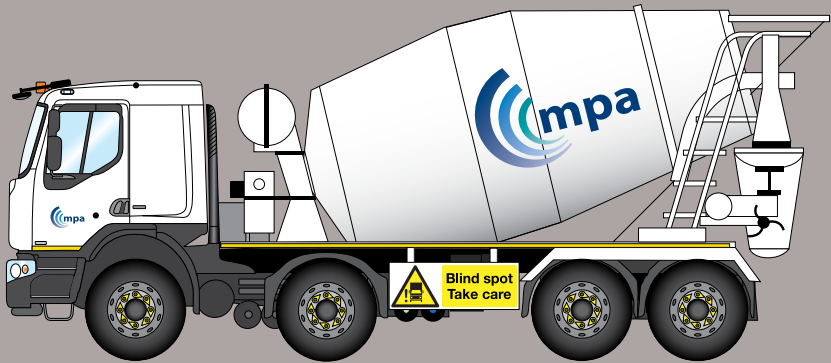
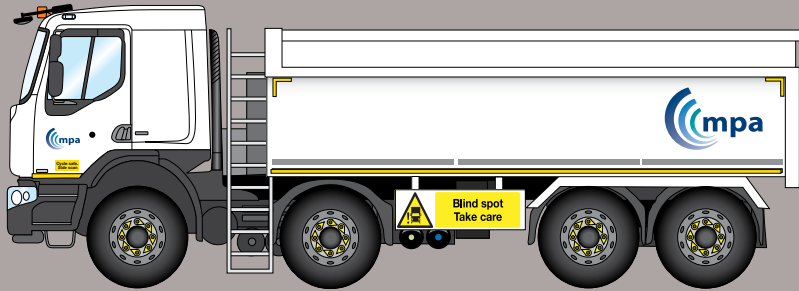

Mineral Products Association

38-44 Gillingham Street
London SW1V 1HU

Tel 020 7963 8000
Fax 020 7963 8001
info@mineralproducts.org
www.mineralproducts.org

© Mineral Products Association 2020

The Mineral Products Association is the trade association for the aggregates, asphalt, cement, concrete, dimension stone, lime, mortar and silica sand industries.

For further MPA information visit www.mineralproducts.org

Printed on paper from well-managed forests, controlled sources and recycled wood or fibre. FSC accredited: TT-COC-002651